

SMART INDUSTRIAL
CONNECTIVITY PORTFOLIO
AUSTRALIAN ISSUE

PORTFOLIO OVERVIEW

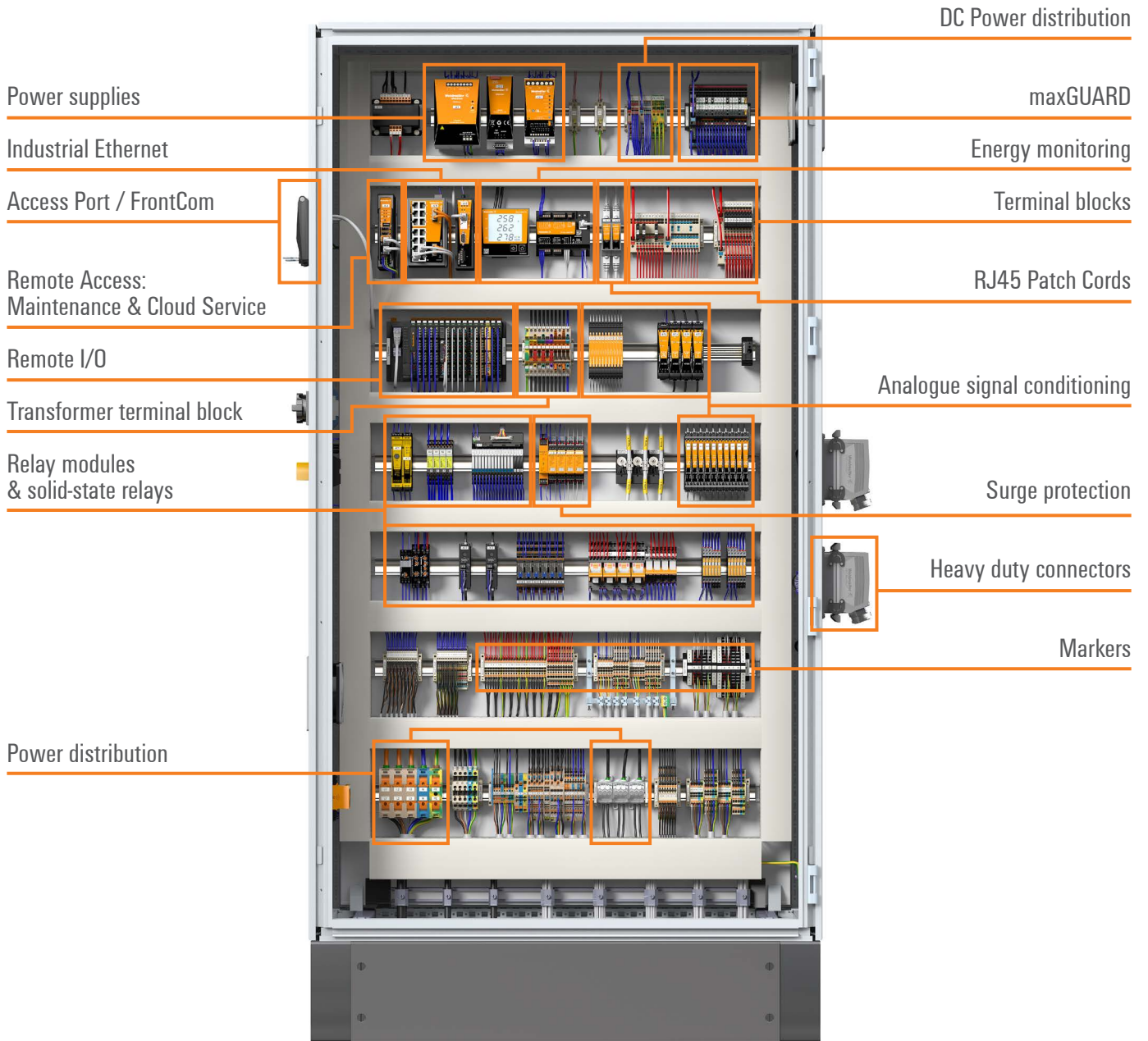

Configuration Software



Weidmüller Configurator

- Simplifies configuration and ordering for extra efficiency in panel planning, installation and operation
- Minimization of failures
- User-friendly
- Easy documentation

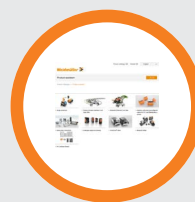

Product Configuration / Selection Software

- Competitive cross-reference database
- Configure custom PCBs, rectangular connectors, Ethernet cabling and connectors, SAI cordsets and connectors

Weidmüller Configurator

Simple and seamless planning tool



Digital engineering can be as simple as that! Create your configuration from over 12,000 digital Weidmüller products.

The Weidmüller Configurator (WMC) is a configuration tool for seamless and secure planning of electrical systems as well as simple procurement and assembly of complete solutions.

Unlock your potential of automated production from paperless production all the way up to automatic manufacturing - in just one tool.

Find more information about the Weidmüller Configurator here:



TABLE OF CONTENTS



4	PUSH IN technology (A-Series)
7	Screw technology (W-Series)
9	Terminal Accessories
10	Power Supplies
11	DC/DC Converter
12	DC UPS
13	Electronic Fuse
14	Industrial Ethernet Switches
15	Rackmount Switches and Routers
16	Industrial Ethernet Connectivity
18	Remote IO
19	Controllers and HMI
20	Energy Metering
21	Termseries PLC Relays
22	General Relays
23	Signal Conditioning
24	Process Displays
25	Surge Protection
26	Heavy Duty Connectors
27	Circular Cordsets
28	Tools
30	Automated Machines
31	Ferrules
32	Markers and Printers
34	Cable Entry Systems

PUSH IN TECHNOLOGY (A-SERIES)

Build with the best with Weidmüller's Klippon Connect range.

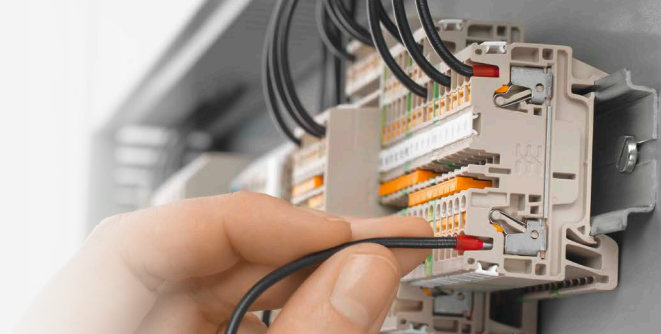
It's our unwavering commitment to quality that has made Weidmüller the name synonymous with terminals in Australia & New Zealand for over 50 years.



Series / family		Application	mm ²	Levels	Connections per level	Description	Standard	Blue	Earth	End Plate
A-series PUSH IN	 A2C A3C	Feed Through	1.5	1	2	A2C 1.5	1552790000	1552820000	1552680000	1552600000
					3	A3C 1.5	1552740000	1552770000	1552670000	1552620000
					4	A4C 1.5	1552690000	1552700000	1552660000	1552640000
				2	2	A2T 1.5	2469370000	2471430000	2469410000	2469420000
					3	A3T 1.5	2816930000	2816940000	2818000000	2816950000
					4	A4C 1.5	1521850000	1521880000	1521680000	1514400000
	2.5		1	3	A3C 2.5	1521740000	1521780000	1521670000	1521510000	
				4	A4C 2.5	1521690000	1521700000	1521540000	1521530000	
				2	A2T 2.5	1547610000	1547620000	1547680000	1547690000	
			2	3	A3T 2.5	2428510000	2428520000	2428550000	2428560000	
				2	A2C 4	2051180000	2051210000	2051360000	2051680000	
				4	A4C 4	2051240000	2051280000	2051410000	2051720000	
	4	1	4	A4C 4	2051500000	2051520000	2051560000	2051900000		
			2	A2T 4	2539970000	2540040000	2539990000	2540000000		
			2	A2C 6	1992110000	1991790000	1991810000	1991970000		
		1	3	A3C 6	1991820000	1991830000	1991850000	1991940000		
			2	A2C 10	2490360000	2490370000	2490440000	2490380000		
			3	A3C 10	2490520000	2490510000	2490590000	2490530000		
	6	1	2	A2C 16	2494000000	2494100000	2494010000	2490380000		
			3	A3C 16	2494090000	2494080000	2494020000	2490530000		
2			A2C 2	2918260000	-	-	1552620000			
2.5		3	ADT 1.5 3C	2918270000	-	-	2918290000			
		2	ADT 2.5 2C	1989800000	1989810000	-	1521530000			
		3	ADT 2.5 3C	1989830000	1989840000	-	1989970000			
10	1	4	ADT 2.5 4C	1989860000	1989870000	-	1989980000			
		2	A2T 2.5 DT/DT	2744110000	2744120000	-	2744150000			
		1	ADT 4 2C	2429850000	2429880000	-	2051720000			
	4	2	A2T 4 DT-FT	2831520000	-	-	-			
		2	A2T 4 DT-FT-PE	2831530000	-	-	2817060000			
		2	AFS 4 2C BK	2429860000	-	-	-			
16	1	2	AFS 4 2C 10-36V BK	2429870000	-	-	2486640000			
		2	AFS 4 2C 100-250V BK	2434390000	-	-	-			
		2	A2T 4 FS-FT BK	2816960000	-	-	2817060000			
	2	2	A2T 4 FS-FT-PE BK	2817010000	-	-	-			
		2	A2C 35	2551510000	2552090000	2551520000	-			
		8	A2C 35 3FT-N	2552130000	-	-	-			
A-Series High Current		Feed Through	35	1	10	A2C 35 3FT-N-PE	2551540000	-	-	-
					2	A2C 50/70	2663250000	2663260000	2663280000	Not Required
					8	A2C 50/70 3FT-N	2663300000	-	-	-
		Feed Through	50/70	1	2	A2C 95/120	2694060000	2694070000	2694090000	-
					8	A2C 95/120 3FT-N	2694120000	-	-	-
					2	A2C 95/120 3FT-N	2694120000	-	-	-

Series / family	mm ²	Description	Red	White	Blue	Black	Orange	Yellow	
Colour versions		2.5	A2C 2.5	1521900000	1521970000	1521880000	1521980000	1521930000	1521940000
		4	A2C 4	2051220000	2051290000	2051210000	2051310000	2051230000	2051250000

Series / family	mm ²	Colour	2-pole	3-pole	4-pole	5-pole	10-pole	20-pole	50-pole
ZQV Cross-connectors	1.5	Orange	1985410000	1985480000	1985490000	1985500000	1985580000	1985600000	1985620000
		Red	1985650000	1985670000	1985690000	1985710000	1985800000	1985810000	1985900000
		Blue	1985530000	1985550000	1985570000	1985590000	1985680000	1985700000	1985720000
		Orange	1527540000	1527570000	1527590000	1527620000	1527690000	1527720000	1527730000
		Red	2108470000	2108690000	2108700000	2108710000	2108910000	2108920000	2109000000
		Blue	1527740000	1527770000	1527780000	1527790000	1527880000	1527890000	1527920000
	2.5	Orange	1527930000	1527940000	1527970000	1527980000	1528090000	2883800000	1528130000
		Red	2460450000	2460810000	2460800000	2460790000	2460740000	2810860000	2460730000
		Blue	1528040000	1528080000	1528120000	1528140000	1528230000	2810850000	1528240000
		Orange	1985740000	1985760000	1985780000		2733970000		
		Orange	2497250000						
		Orange	2497290000						
4	Orange	2634950000							
	Orange	2634950000							

PUSH IN TECHNOLOGY (A-SERIES)

Build with the best with Weidmüller's Klippon Connect range. It's our unwavering commitment to quality that has made Weidmüller the name synonymous with terminals in Australia & New Zealand for over 50 years.

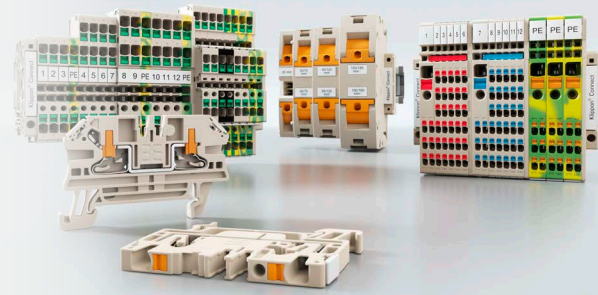



The AAP series can be used to easily provide high density control power distribution to your 24VDC consumers. Simply pick your Feed-in with 6mm² or 10mm² input, and add extension terminals if more load connections are required.

Series / family	Feed-in Size Input	Distribution Size Output loads	Application	Description	Red	Blue	Earth	End Plate
 Control Voltage Distribution	1 x 6mm ²	6 x 1.5mm ²	Feed in + Distribution	AAP11 6/6X1.5 LO-LI	2464690000	2464750000	2464740000	1988320000
	-		Extension	AAP11 1.5 LI	1988160000	1988170000	-	
	1 x 10mm ²	4 x 2.5mm ²	Feed in + Distribution	AAP12 10/4X2.5 LO-LI	2464730000	2464720000	2464710000	1988300000
	-		Extension	AAP12 2.5 LI	1988290000	1988100000	-	

AIO high-density instrumentation terminals. The AIO instrument terminals provide high density connection of signals between the field and PLC.

Series / family	mm ²	Levels	Terminal Configuration	Application	Description	Standard	End Plate
 Signal Wiring PUSH IN A-Series	1.5	2	1 x Red, 1 x Blue, 1 x Signal feedthrough pair	Instrumentation wiring, sensor to PLC	AIO21 1.5 SO	1992240000	1993580000
			1 x Red, 1 x Blue, 1 x Earth, 1 x Signal feedthrough pair		AIO21 1.5 SI	1992260000	
		3	1 x Red, 1 x Blue, 2 x Signal feedthrough pairs		AIO23 1.5 2SI	1992220000	

Series / family	Matching Terminal	Description	Part Number
 Accessories Partition Plates	A2C 1.5, A2C 2.5	APP 1	2488970000
	A3C 1.5, A4C 1.5, A3C 2.5, A4C 2.5, A2C 4, A3C 4, A2C 6, ADT 4	APP 2	2489090000
	A3C 6, AAP11, AAP13, AIO21	APP 3	2489100000
	A2T 1.5, A2T 2.5	APP 4	2489110000

Series / family	Matching Terminal	Description	Part Number
 Accessories Warning Labels	1.5mm ²	AAM 1.5 YELLOW FLASH	2635520000
	2.5mm ²	AAM 2.5 YELLOW FLASH	2635550000
	4mm ²	AAM 4 YELLOW FLASH	2635560000
	6mm ²	AAM 6 YELLOW FLASH	2635570000
	10mm ²	AAM 10 YELLOW FLASH	2635580000
	16mm ²	AAM 16 YELLOW FLASH	2635590000
	35-185mm ²	AAM 35-185 YELLOW FLASH	2635600000

Series / family	mm ²	Colour	2-pole	3-pole	4-pole	5-pole	10-pole	20-pole	50-pole
 ZQV Cross-connectors	1.5	Orange	1985410000	1985480000	1985490000	1985500000	1985580000	1985600000	1985620000
		Red	1985650000	1985670000	1985690000	1985710000	1985800000	1985810000	1985820000
		Blue	1985530000	1985550000	1985570000	1985590000	1985680000	1985700000	1985720000
	2.5	Orange	1527540000	1527570000	1527590000	1527620000	1527690000	1527720000	1527730000
		Red	2108470000	2108690000	2108700000	2108710000	2108910000	2108920000	2109000000
		Blue	1527740000	1527770000	1527780000	1527790000	1527880000	1527890000	1527920000
	4	Orange	1527930000	1527940000	1527970000	1527980000	1528090000	2883800000	1528130000
		Red	2460450000	2460810000	2460800000	2460790000	2460740000	2810860000	2460730000
		Blue	1528040000	1528080000	1528120000	1528140000	1528230000	2810850000	1528240000

See page 32 for marking solutions



PUSH IN TECHNOLOGY (A-SERIES)

Klippon A-Series with side PUSH IN connection.
 Enjoy the advantages of PUSH IN technology with the increased wiring visibility and decreased installation height with side-entry wiring.

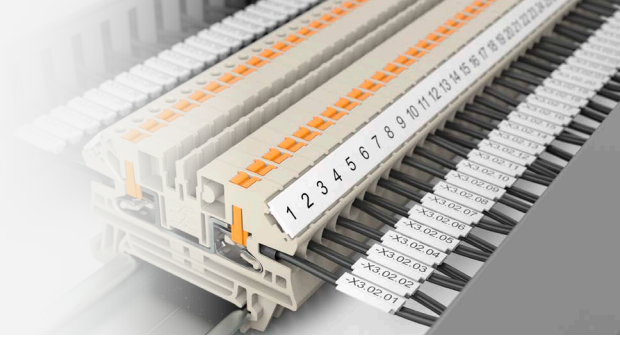

Series / family	Application	mm ²	Levels	Connections per level	Description	Standard	Blue	Earth	End Plate
AL-Series PUSH IN Side Entry	Feed Through	2.5	1	2	AL2C 2.5	2847200000	2847210000	2847590000	2871750000
				3	AL3C 2.5	2847330000	2847340000	2847600000	2871770000
		4		AL4C 2.5	2847460000	2847470000	2847610000	2871790000	
		2		AL2C 4	2847710000	2871870000	2847740000	2871810000	
	Disconnect	2.5	1	3	AL3C 4	2847720000	2871990000	2847750000	2871830000
				4	AL4C 4	2847730000	2872110000	2847770000	2871850000
	Fuse (5x20)	4	1	2	ALDT 2.5 2C	2898660000	2898670000	-	2898830000
				3	ALDT 2.5 3C	2898700000	2898710000	-	2898850000
				2	ALDT 4 2C	2898740000	2898750000	-	2898890000
				2	ALFS 4 2C BK	2898780000	-	-	-
					ALFS 4 2C 10-36V BK	2898790000	-	-	2898890000
					ALFS 4 2C 100-250V BK	2898820000	-	-	-

TTB current transformer test/disconnect terminals. Isolate current transformers safely and easily with the Klippon TTB series. Featuring new make-before-break functionality, CT testing and maintenance can be performed as simple as turning a switch!

Series / family	mm ²	Phases	Application	Screw Terminal	Part Number	PUSH-IN	Part Number
TTB Current transformer disconnect kits	6	1	Single phase CT metering	WTTB CT KIT 1PH	7940127529	ATTB CT KIT 1PH	7940127934
		3	3-phase CT metering with or without earth	WTTB CT KIT 3PH	7940127530	ATTB CT KIT 3PH	7940127935
		3+E		WTTB CT KIT 3PH+E	7940127531	ATTB CT KIT 3PH+E	7940127936
		3+N+E	3 Phase + Neutral CT metering with earth	WTTB CT KIT 3PH+N+E	7940127938	ATTB CT KIT 3PH+N+E	7940127937
		3+E+VT	3 Phase CT + voltage feedthrough metering with earth	WTTB CT KIT 3PH+E+VT	7940127532	ATTB CT KIT 3PH+E+VT	7940128855

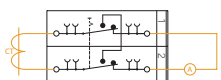
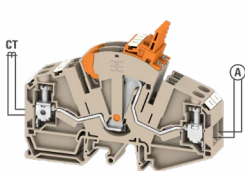

Wiring of current transformer and ammeter

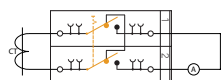
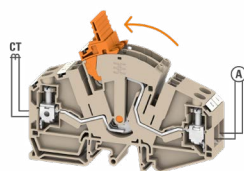

Switching the lever link

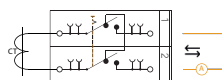
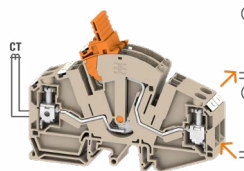

Replacing the ammeter

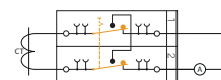
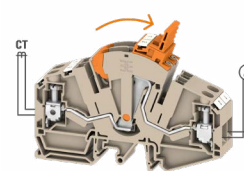



Restoring the lever link back into original position

SCREW TECHNOLOGY (W-SERIES)

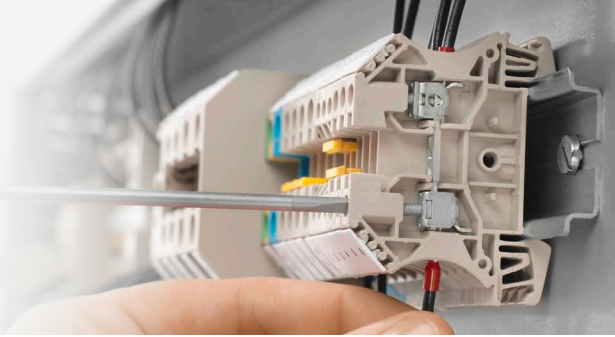
We set the standard for screw clamp technology. Our W-Series range has been the most popular and reliable screw connection terminal favoured across Australia & New Zealand for more than 50 years.

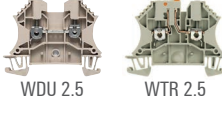

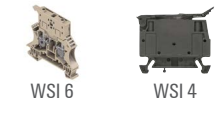
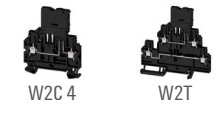
Series / family	Application	mm ²	Levels	Connections per level	Description	Standard	Blue	Earth	End Plate	
W-series Screw Terminal    	Feed Through	2.5	1	2	WDU 2.5 ●●	1020000000	1020080000	1010000000	1050000000	
			2		WDK 2.5 ●	1021500000	1021580000	1036300000	1059100000	
			3		WDK 2.5 ZQV ●	1041100000	1041180000	-	-	
		4	1		WDK 2.5N ●	1041600000	1041680000	1041620000	1084000000	
			2		DLD 2.5 DB	1784180000	6269250000	-	1784210000	
		6	1		WDU 4 ●●	1020100000	1020180000	1010100000	1050000000	
					WDK 4N ●	1041900000	1041980000	1041920000	1084000000	
					WDU 6 ●	1020200000	1020280000	1010200000	1050000000	
					WDU 10 ●	1020300000	1020380000	1010300000	1050000000	
					WDU 16 ●	1020400000	1020480000	1010400000	1050100000	
					WDU 35 ●	1020500000	1020580000	1010500000	1050000000	
					WDU 50N	1820840000	1820850000	1846040000	-	
					WDU 70N/35	9512190000	9512420000	9512200000	-	
					WDU 70/95	1024600000	-	1037300000	-	
					WDU 95N/120N	1820550000	-	1846030000	-	
		Disconnect	2.5		1	WTR 2.5 ●	1855610000	8731640000	-	1050000000
						WTR 2.5 STB2.3 ●●	1855620000	8731660000	-	-
					2	WDTR 2.5	2456000000	2456010000	-	-
	4		1	WTR 4 ●	7910180000	7910190000	-	-		
				WTR 4 STB ●●	7910210000	7910220000	-	1050000000		
				WTR 4 STB ●●	7910210000	7910220000	-	-		
	Fuse (5x20)	2.5	1	WTR 2.5/SI ●	1763940000	-	-	-		
				WFS 4 ●	2561900000	-	-	-		
				WSI 4	1886580000	-	-	-		
4		2	W2C 4 FS BK ●	2892920000	-	-	2894230000			
			W2T 4 FS-FT BK STB ●●	2894000000	-	-	2894260000			
			WSI 6	1011000000	1011080000	-	-			
6	1	WSI 6/LD 10-36V DC/AC	1011300000	-	-	1050000000				

- With test socket
- Supports ZQV cross connect
- Supports ZQV cross connect

Series / family	mm ²	Connections	Stud Thread	Application	Description	Part Number
WFF Stud terminal 	35	2	M6	Stud terminal with protective covers	WFF 35/AH	1029300000
	70		M8		WFF 70/AH	1029400000
	120		M10		WFF 120/AH	1029500000
	185		M12		WFF 185/AH	1029600000
	300		M16		WFF 300/AH	1029700000











Series / family	mm ²	Colour	2-pole	3-pole	4-pole	5-pole	10-pole	20-pole	50-pole
ZQV Cross-connectors 	2.5	Orange	1527540000	1527570000	1527590000	1527620000	1527690000	1527720000	1527730000
		Red	2108470000	2108690000	2108700000	2108710000	2108910000	2108920000	2109000000
		Blue	1527740000	1527770000	1527780000	1527790000	1527880000	1527890000	1527920000
	4	Orange	1527930000	1527940000	1527970000	1527980000	1528090000	2883800000	1528130000
		Red	2460450000	2460810000	2460800000	2460790000	2460740000	2810860000	2460730000
		Blue	1528040000	1528080000	1528120000	1528140000	1528230000	2810850000	1528240000

Series / family	mm ²	Colour	2-pole	3-pole	4-pole	5-pole	10-pole	20-pole	50-pole
WQV Cross-connectors 	2.5	Yellow	1053660000	1053760000	1053860000	1053960000	1054460000	1577570000	-
	4		1051960000	1054560000	1054660000	1057860000	1052060000	-	-
	6		1052360000	1054760000	1054860000	1062660000	1052260000	-	-
	10		1052560000	1054960000	1055060000	2091130000	1052460000	-	-
	16		1053260000	1055160000	1055260000	-	1053360000	-	-
	35		1053060000	1055360000	1055460000	-	1053160000	-	-



SCREW TECHNOLOGY (W-SERIES)

We set the standard for screw clamp technology. Our W-Series range has been the most popular and reliable screw connection terminal favoured across Australia & New Zealand for more than 50 years.





Series / family	mm ²	Connections per level	Levels	Application	Description	Standard	Earth	End Plate
W-Series DCS Marshalling   W2C FT W2C FT PE   W2C DT W2C DT PE   W2C FS W2C FS PE   W2T DT-FT W2T DT-FT PE   W2T FS-FT W2T FS-FT PE	4	2	1	Feed Through	W2C 4 FT STB ●●	2892680000	2892700000	2894210000
				Disconnect	W2C 4 DT STB ●●	2892770000	2892820000	2894210000
				Fuse (5x20)	W2C 4 FS BK STB ●●	2892930000	2893130000	2894230000
			2	Disconnect + Feed Through	W2T 4 DT-FT STB ●●	2893720000	2893740000	2894240000
				Fuse (5x20) + Feed Through	W2T 4 FS-FT BK STB ●●	2894000000	2894100000	2894260000

- With test socket
- Supports ZQV cross connect

Series / family	mm ²	Colour	2-pole	3-pole	4-pole	5-pole	10-pole	20-pole	50-pole
ZQV Cross-connectors   	4	Orange	1527930000	1527940000	1527970000	1527980000	1528090000	2883800000	1528130000
		Red	2460450000	2460810000	2460800000	2460790000	2460740000	2810860000	2460730000
		Blue	1528040000	1528080000	1528120000	1528140000	1528230000	2810850000	1528240000

WPD Phase Distributor. WPD feed-in terminal blocks allow for an easy and safe installation of aluminium and copper conductors in a small footprint.

Series / family	Feeder Size mm ²	Connections	Application	Grey (white)	Red	Blue	Black
WPD Phase Distributor 	25	1x25mm ² + 1x16mm ² / 2x16mm ² + 3x10mm ²	Phase Distribution	1562000000	2725260000	2518250000	2725360000
	35	1x35mm ² + 1x16mm ² / 2x25mm ² + 3x16mm ²		1562170000	2725310000	2518540000	2725410000
	70	1x70mm ² / 2x25mm ² + 3x16mm ²		1562210000	2725340000	2518570000	2725440000
	95	1x95mm ² / 2x35mm ² + 8x25mm ²		1562220000	2725350000	2521730000	2725450000
	120	1x120mm ² / 2x35mm ² + 3x25mm ² + 4x16mm ²		1562100000	2725280000	2519480000	2725380000
	185	1x185mm ² / 2x35mm ² + 3x25mm ² + 4x16mm ²		1562090000	2725270000	2519490000	2725370000

Series / family	Matching Terminal	Description	Part Number
Accessories Test Plug 	*With test socket	PS 2.3 RT	0180400000

See page 32 for marking solutions

TERMINAL ACCESSORIES

Build with the best with Weidmüller's Klippon Connect range. It's our unwavering commitment to quality that has made Weidmüller the name synonymous with terminals in Australia for over 50 years.



Series / family	Size	Type	Height	Material	Length	Description	Part Number
DIN Rail	TS 15	Slotted	5.5mm	Steel, zinc plated, passivated	2m	TS 15X5/LL 2M/ST/ZN	0117500000
		No Slot				TS 32X15 2M/ST/ZN	0122800000
		Slotted				TS 32X15/LL 2M/ST/ZN	0514400000
		No Slot				TS 32X15 2M/CRN	0293220000
	TS 32	15mm	No Slot	Aluminium		TS 32X15 2M/AL/BK	0169300000
			Slotted	Steel, zinc plated, passivated		TS 35X7.5 2M/ST/ZN	0383400000
		7.5mm	No Slot	Stainless steel		TS 35X7.5/LL 2M/ST/ZN	0514500000
			Slotted	Aluminium		TS 35X7.5/LL/6 2M/ST/ZN	0514570000
	TS 35	15mm	No Slot	Steel, zinc plated, passivated		TS 35X7.5 2M/CRN	1747350000
			Slotted	Aluminium		TS 35X7.5 2M/AL/BK	0330800000
		7.5mm	No Slot	Stainless steel		TS 35X15 2M/ST/ZN	0236400000
			Slotted	Steel, zinc plated, passivated		TS 35X15/LL 2M/ST/ZN	0236500000
15mm	No Slot	PVC	TS 35X15/6X18 2M/ST/ZN	1805980000			
	Slotted	PVC	TSK 35X15 2M PVC/GR	0514300000			

Series / family	Size	Type	Height	Material	Description	Part Number
DIN Rail End Cap	TS 35	7.5mm	7.5mm	Polypropylene	TS END CAP 35X7.5	1283470000
		15mm	15mm		TS END CAP 35X15	1283480000

Series / family	Terminal Series	Application	Description	Standard	Black
End Bracket	A	End Bracket Screw Clamp	AEB 35 SC/1	1991920000	2475310000
	W		WEW 35/1	1059000000	1162600000
	W		WEW 35/2	1061200000	1061210000
	A	Snap On	AEB 35 SCL/1 V0	2661280000	2661300000
	Z		ZEW 35	9540000000	-
	Z		ZEW 35/2	8630740000	1162610000

Series / family	Size	Rated Current	Characteristics	Description	Part Number
Fuse cartridge	5 x 20	0.1A	Fast Blow 1.5kA breaking capacity	G 20/0.10A/F	0430300000
		0.2A		G 20/0.20A/F	0430400000
		0.25A		G 20/0.25A/F	0430500000
		0.5A		G 20/0.50A/F	0430600000
		0.63A		G 20/0.63A/F	0439000000
		1A		G 20/1.00A/F	0430700000
		1.6A		G 20/1.60A/F	0430800000
		2A		G 20/2.00A/F	0430900000
		2.5A		G 20/2.50A/F	0431000000
		3.15A		G 20/3.15A/F	0431100000
		4A		G 20/4.00A/F	0431200000
		5A		G 20/5.00A/F	0431300000
		6.3A		G 20/6.30A/F	0431400000

Series / family	Type	Description	Part Number
Fuse Holder	Fuse holder	ZST 1	1269070000









Series / family	Width	Application	Description	Part Number
Tag Holder	7.2mm	Suits WEW 35/2, ZEW 35, AEB 35 SC/1	EM 8/30	1806120000
	9.5mm	Group marker carrier, DIN mount	SCHT 5 S	1631930000
	19.5mm		SCHT 5	0292460000



POWER SUPPLIES

Reliable production requires a reliable power source. We have solutions to suit your simplest control board to your most complex and critical plant operations.





Series / family		Voltage	Output	Description	Single Phase	Three Phase		
 <p>PRObas</p> <p>Entry level, for general industrial loads</p>		5V DC	6A	PRO BAS 30W 5V 6A	2838400000	-		
			2.6A	PRO BAS 30W 12V 2.6A	2838510000	-		
		12V DC	5A	PRO BAS 60W 12V 5A	2838420000	-		
			10A	PRO BAS 120W 12V 10A	2838450000	-		
		24V DC	1.3A	PRO BAS 30W 24V 1.3A	2838500000	-		
			2.5A	PRO BAS 60W 24V 2.5A	2838410000	-		
			5A	PRO BAS 120W 24V 5A	2838440000	-		
			10A	PRO BAS 240W 24V 10A	2838460000	-		
		48V DC	20A	PRO BAS 480W 24V 20A	2838480000	-		
			5A	PRO BAS 240W 48V 5A	2838470000	-		
		10A	PRO BAS 480W 48V 10A	2838490000	-			
 <p>PROeco</p> <p>Standard range, wide range options for single and 3-phase</p>		12V	6A	PRO ECO 72W 12V 6A	1469570000	-		
			10A	PRO ECO 120W 12V 10A	1469580000	-		
		24V	3A	PRO ECO 72W 24V 3A	1469470000	-		
			5A	PRO ECO 120W 24V 5A	1469480000	-		
						-	1469530000	
			10A	PRO ECO 240W 24V 10A	1469490000	-		
						-	1469540000	
			20A	PRO ECO 480W 24V 20A	1469510000	-		
		48V	40A	PRO ECO 960W 24V 40A	1469520000	-		
						-	1469560000	
		5A	PRO ECO 240W 48V 5A	1469590000	-			
		10A	PRO ECO 480W 48V 10A	1469610000	-			
 <p>PROmax</p> <p>Mid Level, 300% top boost for demanding loads</p>		5V	14A	PRO MAX 70W 5V 14A	1478210000	-		
			12V	6A	PRO MAX 72W 12V 6A	1478220000	-	
		10A		PRO MAX 120W 12V 10A	1478230000	-		
		24V	3A	PRO MAX 72W 24V 3A	1478100000	-		
			5A	PRO MAX 120W 24V 5A	1478110000	-		
						-	1478170000	
			7.5A	PRO MAX 180W 24V 7.5A	1478120000	-		
			10A	PRO MAX 240W 24V 10A	1478130000	-		
			20A	PRO MAX 480W 24V 20A	1478140000	-		
		48V	40A	PRO MAX 960W 24V 40A	1478150000	-		
				-	1478200000			
		5A	PRO MAX 240W 48V 5A	1478240000	-			
		10A	PRO MAX 480W 48V 10A	1478250000	-			
		20A	PRO MAX 960W 48V 20A	1478270000	-			
 <p>PROtop</p> <p>Top Level, 600% top boost, High Reliability, for heavy loads and circuit breaker tripping. Direct parallel connection without diode module via built-in ORing MOSFET</p>		12V	10A	PRO TOP1 120W 12V 10A	2466910000	-		
						PRO TOP1 120W 12V 10A EX ●	2467020000	-
		24V	3A	PRO TOP1 72W 24V 3A	2466850000	-		
						PRO TOP1 72W 24V 3A CO ●	2466970000	-
			5A	PRO TOP1 120W 24V 5A	2466870000	-		
							-	2467060000
						PRO TOP1 120W 24V 5A EX ●	2466980000	-
						PRO TOP3 120W 24V 5A CO ●	-	2467070000
		10A	PRO TOP1 240W 24V 10A	2466880000	-			
						-	2467080000	
			PRO TOP1 240W 24V 10A EX ●	2466990000	-			
						PRO TOP3 240W 24V 10A CO ●	-	2467090000
		20A	PRO TOP1 480W 24V 20A	2466890000	-			
						-	2467100000	
			PRO TOP1 480W 24V 20A EX ●	2467000000	-			
						PRO TOP3 480W 24V 20A CO ●	-	2467110000
		40A	PRO TOP1 960W 24V 40A	2466900000	-			
						-	2467120000	
			PRO TOP1 960W 24V 40A EX ●	2467010000	-			
						PRO TOP3 960W 24V 40A CO ●	-	2467130000
48V	10A	PRO TOP1 480W 48V 10A	2467030000	-				
				-	2467150000			
				PRO TOP1 480W 48V 10A EX ●	2467040000	-		
				PRO TOP3 480W 48V 10A CO ●	-	2467160000		
	20A	PRO TOP1 960W 48V 20A	2466920000	-				
					-	2467170000		
			PRO TOP1 960W 48V 20A CO ●	2467050000	-			
			PRO TOP3 960W 48V 20A CO ●	-	2467180000			

DC/DC CONVERTER

Flexible, reliable and safe in every environment.
Our buffer modules, redundancy modules and DC/DC converters improve the reliability and flexibility of your systems



Series / family	Nominal Voltage	Redundancy Type	Technology	Voltage Drop	Description	Part Number
 PRO DM10 PRO RM10 PRO RM40	0-60 VDC	2 x 10A	Diode	Vin - 0.7V	PRO DM 10	2486070000
		2 x 20A			PRO DM 20	2486080000
	12 / 24 VDC	2 x 10A	MOSFET	< Vin - 0.2V	PRO RM 10	2486090000
		2 x 20A			PRO RM 20	2486100000
		2 x 40A			PRO RM 40	2486110000

Series / family	Nominal Input	Min/Max Voltage Input	Nominal Output	Min/Max Voltage Output	Rated Current	Description	Part Number	
 PRO DCDC 10A PRO TOPDC 10A	12 VDC	9-18V DC	12V DC	5-15V DC	8A	PRO DCDC 96W 12V/12V 8A	2869000000	
			24V DC	22-29V DC	5A	PRO DCDC 120W 12V/24V 5A	2869030000	
			12V DC	5-15V DC	8A	PRO DCDC 96W 24V/12V 8A	2869010000	
	24V DC	18-32V DC	24V DC	22-29V DC	5A	PRO DCDC 120W 24V 5A	2001800000	
						PRO TOPDC 24V/24V 5A	2627650000	
						PRO DCDC 240W 24V 10A	2001810000	
					10A	PRO TOPDC 24V/24V 10A	2627640000	
						20A	PRO DCDC 480W 24V 20A	2001820000
							PRO TOPDC 24V/24V 20A	2627630000
	48V DC	28-58V DC	48V DC	29-56V DC	5A	PRO DCDC 240W 24V/48V 5A	2869050000	
					10A	PRO TOPDC 24V/48V 10A	2627660000	
					8A	PRO DCDC 96W 48V/12V 8A	2869020000	
	48V DC	28-58V DC	48V DC	22-29V DC	5A	PRO DCDC 120W 48V/24V 5A	2869040000	
					5A	PRO DCDC 240W 48V/48V 5A	2869060000	
					5A	PRO DCDC 240W 48V/48V 5A	2869060000	

Series / family	Voltage	Output	Phase	Description	Part Number
 Compact, for small loads and light control	5V	6A	1	PRO INSTA 30W 5V 6A	2580210000
		12V		2.6A	PRO INSTA 30W 12V 2.6A
	24V			5A	PRO INSTA 60W 12V 5A
		0.7A		PRO INSTA 16W 24V 0.7A	2580180000
		1.3A		PRO INSTA 30W 24V 1.3A	2580190000
		2.5A		PRO INSTA 60W 24V 2.5A	2580230000
		4A		PRO INSTA 96W 24V 4A	2580260000
		2A		PRO INSTA 96W 48V 2A	2580270000

Power Supply Surge Protection

Series / family	Network	Voltage	I _{max} (8/20 _{us})	Application	Fault Contact	Description	Part Number
Accessories	1-phase	240 VAC	20kA	Power supply surge protection	Yes	VPU AC II+III 1+1 R 275/20 S	2907940000
	3-phase					VPU AC II+III 3 R 275/20 S	2907880000

DC UPS

Avoid costly machine downtimes machine downtimes. Weidmüller's uninterruptible power supplies reliably protect 24 V DC consumers from power failures and voltage drops, which can affect system availability. Together with the associated battery module and the power supply unit, the UPS control unit forms a complete DC UPS system with backup times in the range of minutes to hours.



DC Buffering

1. If your duration is short (<5s), consider using a buffer module, otherwise consider a DC UPS.
2. Determine your maximum load current and maximum buffering time.
3. Refer to the battery selection table to choose the most suitable battery to go with your DC UPS.

Series / family	Nominal Voltage	Rated Current	Buffer Duration	Technology	Description	Part Number
DC UPS	24V DC	20A	-	VRLA charger	DC UPS 24V 10/20A	1370050010
		40A			DC UPS 24V 40A	1370040010
 DC UPS Controller PRO DC Buffer	24V DC	15A	6 min @ 5A	VRLA AGM	DURA ECO LA-BAT 24V 1.2AH	2789890000
		25A	10 min @ 10A		DURA ECO LA-BAT 24V 3.4AH	2789900000
		50A	23 min @ 10A		DURA ECO LA-BAT 24V 7AH	2789910000
			50 min @ 10A		DURA ECO LA-BAT 24V 12AH	2789920000
			72 min @ 10A		DURA ECO LA-BAT 24V 17AH	2789930000
Buffer Module	24V DC	20A	320ms @ 20A	Capacitor	PRO DC BUFFER 24V 20A	2786240000
		40A	230ms @ 40A		PRO DC BUFFER 24V 40A	2786250000

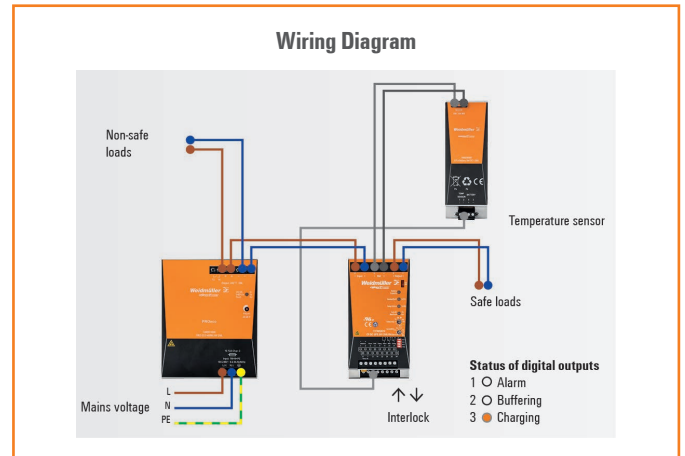
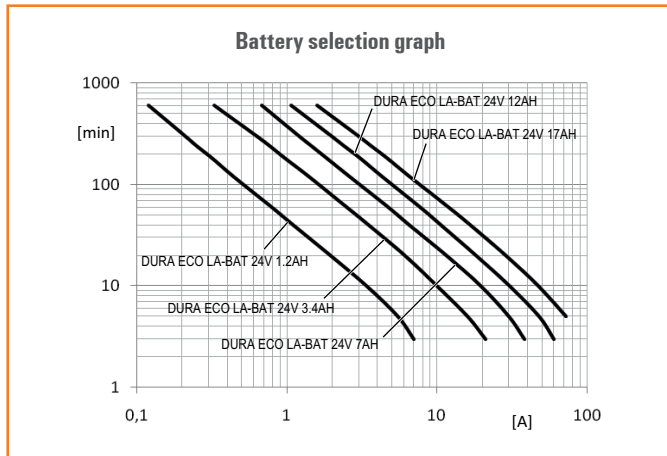



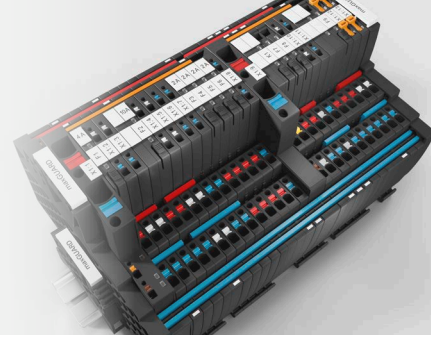

ELECTRONIC FUSE



maxGUARD. The modular electronic fuse. Protect your control voltage distribution with the flexible and modular maxGUARD electronic fuse terminal range.



Series / family	Function	Description	Part Number
maxGUARD Feed in modules	 AMG FIM	Feed in module basic. 40A max.	AMG FIM-0 2081870000
		Feed in module with remote reset and alarm. 40A max	AMG FIM-C 2081880000

Series / family	Function	Description	Part Number
maxGUARD function modules	  AMG CM AMG AM	Optional control module, with remote reset, alarm, >90% pre-warning alarm, ON/OFF. Use with AMG FIM-0	AMG CM 2081900000
		Optional alarm module with relay contacts for trip alarm & >90% pre-warning	AMG AM 2081890000

Series / family	Nominal Voltage	Rated Current	Adjustable	Description	Part Number
maxGUARD Electronic fuse modules	  AMG ELM 1-6A AMG ELM 10-18A	1A	Fixed	AMG ELM-1F	2080420000
		2A		AMG ELM-2F	2080480000
		4A		AMG ELM-4F	2080490000
		6A		AMG ELM-6F	2080500000
		8A		AMG ELM-8F	2080600000
		10A		AMG ELM-10F	2080650000
		0.1A, 0.2A, 0.5A, 0.8A, 1A	Yes	AMG ELM-1 LIM CL2 EX	2838530000
		1A, 2A, 3A, 4A, 6A		AMG ELM-6	2080360000
		4A, 6A, 8A, 10A, 12A		AMG ELM-12	2080410000
		10A, 12A, 14A, 16A, 18A		AMG ELM-18	2859800000
		1A, 2A, 3A, 4A, 6A		AMG ELM-6D CO	2082440000
		4A, 6A, 8A, 10A		AMG ELM-10D CO	2082470000

Series / family	Poles	Description	Red	Blue	Orange	
Cross Connect	 	10	ZQV 4N/10	2460740000	1528230000	1528090000
		50	ZQV 4N/50	2460730000	1528240000	1528130000

maxGUARD modular Electronic Fuse

- Select feed in module depending if you need remote reset or not.
- Select your required electronic fuse cards depending on your loads. Keep in mind not to exceed 40A max.
- Select your cross connects for the positive, negative and communication channels. If the total current is >20A, you will need to use 2 cross connects each for the positive and negative channels.

Notes:



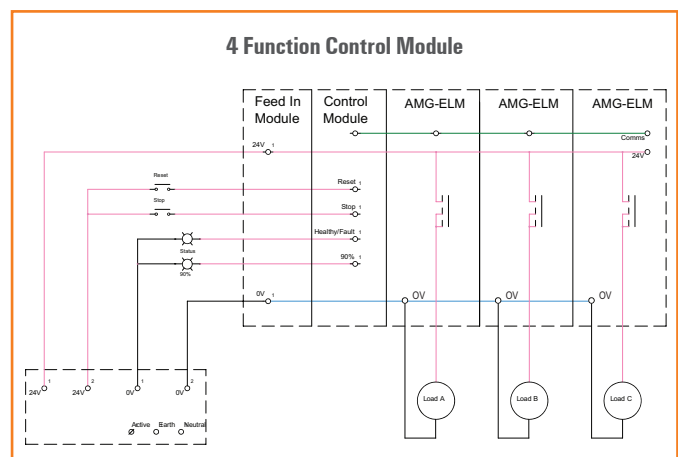
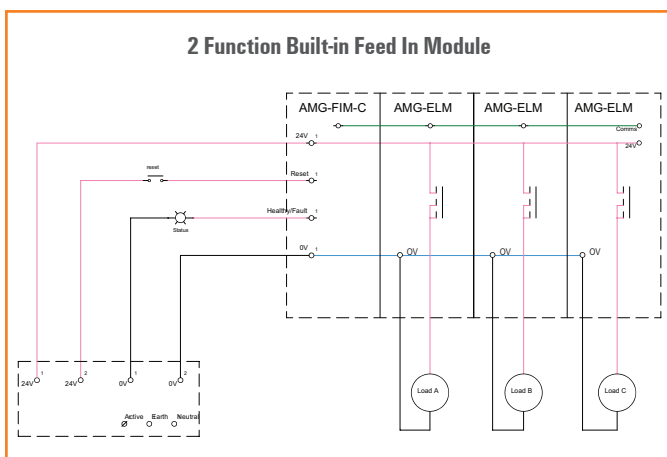

- Maximum limit of 25 fuse modules on a single AMG FIM-C or AMG CM module.
- EX, conformal coated fuses and additional accessories are available from the full catalogue.



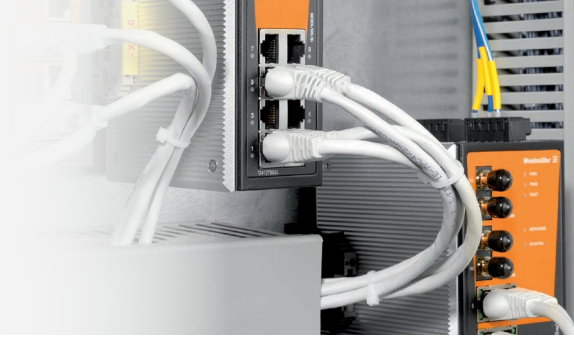

INDUSTRIAL ETHERNET SWITCHES

Stable process control requires a stable communication base.
 Weidmüller's range of industrial ethernet switches provide the perfect link for data communication between Ethernet enabled devices in industrial automation. We offer a wide range of products to suit requirements in industrial networking.



Series / family	RJ45 Ports	Fibre Ports	SFP Ports	Speed	Temperature	Application	Power	Description	Part Number
B-Series Unmanaged Switch 	5	-	-	10/100	-10°C to 60°C	Entry level networking applications, PROFINET conformance class A	12-48VDC, 24VAC	IE-SW-ELB-05-5TX	2828540000
	8	-	-	Gigabit				IE-SW-ELB-08-8TX	2828550000
	5	-	-					IE-SW-ELB-05-5GT	2828560000
	8	-	-					IE-SW-ELB-08-8GT	2828570000
	4	-	1	10/100				IE-SW-ELB-05-4TX-1FESFP	2828590000
	6	-	2					IE-SW-ELB-08-6TX-2FESFP	2828600000
	16	-	-					IE-SW-ELB-16-16TX	2828580000
Ecoline Unmanaged Switch 	5	-	-	10/100	-40°C to 75°C	General Networking Applications	12-48VDC, 24VAC redundant	IE-SW-EL05-5TX	2682130000
	8	-	-	Gigabit				IE-SW-EL08-8TX	2682140000
	5	-	-					IE-SW-EL05-5GT	2682210000
	4	-	1					IE-SW-EL05-4GT-1GESFP	2682220000
	8	-	-	Compact Width		IE-SW-EL08-8GT	2682230000		
	8	-	-			IE-SW-EL08-8GT-MINI	2705000000		
	6	2 x SC MM	-	10/100		General Networking Applications	12-48VDC	IE-SW-EL08-6TX-2SC	2682170000
	6	2 x SC SM	-	10/100+ 2xGigabit				IE-SW-EL08-6TX-2SCS	2682180000
	16	-	-			IE-SW-EL16-16TX	2682150000		
	14	-	2			IE-SW-EL16-14TX-2FESFP	2682160000		
	18	-	2	10/100		IE-SW-EL18-16TX-2GC	2682200000		
	24	-	-			IE-SW-EL24-24TX	2682190000		
	8	-	2	Gigabit		IE-SW-EL10-8GT-2GESFP	2682240000		
	Ecoline PoE Switch 	4	2 x SC MM	-		10/100	-40°C to 75°C	PoE 802.3af/at	12-48VDC redundant
8		-	-	Gigabit	Gigabit PoE 802.3af/at 120W Budget	IE-SW-EL8-8PoE		2682380000	
8		-	-		Gigabit PoE Injector 802.3af/at 60W Budget	IE-SW-EL8-8GTPoE		2682400000	
8		-	2		IE-SW-EL10-8GTPoE-2GESFP	2682410000			
2		-	-	IE-INJ-EL02-2GTPoE	2682440000				
AdvancedLine Managed Switch 		5	-	-	10/100	-40°C to 75°C		Lite Managed, Economical Ring Switch	
	4	2 x SC MM	-	IE-SW-AL06LM-4TX-2SC			2682260000		
	4	2 x SC SM	-	IE-SW-AL06LM-4TX-2SCS			2682270000		
	8	-	-	General Managed Networking	IE-SW-AL08M-8TX		2682280000		
	16	-	-		IE-SW-AL16M-16TX		2682310000		
	24	-	-		IE-SW-AL24M-24TX		2682320000		
	8	-	-		IE-SW-AL08M-6TX-2GT		2682290000		
	10	-	2	10/100+ 2xGigabit Combo	IE-SW-AL10M-8TX-2GC		2740420000		
	18	-	2	Gigabit	IE-SW-AL18M-16TX-2GC		2682330000		
	8	-	-		IE-SW-AL8M-8GT		2682350000		
	8	-	4		Profinet & Ethernet/IP Protocol Support		IE-SW-AL12M-8GT-4GESFP	2682340000	
	12	-	2		IE-SW-AL14M-12GT-2GESFP		2682360000		
	16	-	8		IE-SW-AL24M-16GT-8GESFP		2682370000		
AdvancedLine Managed PoE Switch 	4	-	2		Gigabit	-40°C to 75°C	Gigabit PoE 802.3af/at 120W budget	12-48VDC redundant	IE-SW-AL06M-4GTPoE-2GESFP
	8	-	-	IE-SW-AL08M-8GTPoE					2682420000



Series / family	Speed	Mode	Distance	Description	Part Number
SFP Modules 	10/100mb/s	Multimode	2km	IE-SFP-1FE-MM-2	2682450000
		Singlemode	30km	IE-SFP-1FE-SM-30	2682460000
			60km	IE-SFP-1FE-SM-60	2682470000
	Gigabit	Multimode	0.5km	IE-SFP-1GE-MM-05	2682480000
			2km	IE-SFP-1GE-MM-2	2682490000
		Singlemode	10km	IE-SFP-1GE-SM-10	2682500000
			40km	IE-SFP-1GE-SM-40	2682510000

Series / family	Network	Voltage	Class	I _{max} (8/20us)	Application	Description	Part Number
Accessories 	Data	48 VDC	-	10kA	Cat6A cabling, suitable for PoE devices to 802.3af/at/bt	VDATA CAT6	1348590000
	Data				Cat5E cabling, suitable for PoE devices to 802.3af/at/bt	VDATA CAT5E	2916360000

RACKMOUNT SWITCHES AND ROUTERS

Stable process control requires a stable communication base.
Managed switches supporting energy industry requirements of 61850-3





Series / family	RJ45 Ports	SFP Ports	Speed	Application	Power	Description	Part Number
61850-3 DIN Mount Managed Switch 	10	3	10/100+ 3xGigabit Combo	IEC 61850-3 Substation	12 / 24 / 48 VDC	IE-SW-SL10M-7TX-3GC-LV	2778960000
					110/220 VDC 110/230 VAC	IE-SW-SL10M-7TX-3GC-HV	2778950000
	8	12	Gigabit		12 / 24 / 48 VDC	IE-SW-SL20M-8GT-12GESFP-LV	2778980000
					110/220 VDC 110/230 VAC	IE-SW-SL20M-8GT-12GESFP-HV	2778970000
61850-3 19" Rackmount Managed Switch 	24	2	10/100+ 2xGigabit Combo	IEC 61850-3 Substation	24 / 28 VDC	IE-SW-SL26M-24TX-2GC-LV	2779000000
					110/220 VDC 110/230 VAC	IE-SW-SL26M-24TX-2GC-HV	2778990000

Series / family	Total Slots	Application	Power	Description	Part Number
61850-3 19" Modular Rackmount Managed Switch 	4 (M1, M2, M3, M4)	IEC 61850-3 Substation	24 / 28 VDC	IE-SW-SL28M-LV	2779020000
			110/220 VDC 110/230 VAC	IE-SW-SL28M-HV	2779010000
61850-3 19" Modular Rackmount Layer 3 Managed Switch	4 (M1, M2, M3, M4)	IEC 61850-3 Substation, routing	24 / 28 VDC	IE-SW-L3-SL28M-LV	2875590000
			110/220 VDC 110/230 VAC	IE-SW-L3-SL28M-HV	2875580000

Series / family	Port Type	Supported Slots	Application	Description	Part Number
Modular Plug-in modules 	8 x 10/100/1000 BaseT(X) RJ45	M1, M2, M3	To suit IE-SW-SL28M series	IE-SWM-SL08-8GT	2779140000
	8 x 100/1000Base SFP			IE-SWM-SL08-8GESFP	2779150000
	4 x 100BaseFX SC			IE-SWM-SL04-4SC	2779170000
	4 x 100BaseFX SCS			IE-SWM-SL04-4SCS	2779160000
	4 x 100BaseFX ST			IE-SWM-SL04-4ST	2779190000
	4 x 100BaseFX STS			IE-SWM-SL04-4STS	2779180000
	4 x 1000Base SFP	M4		IE-SWM-SL04-4GESFP	2779200000
	2 x 10GBaseSFP+			IE-SWM-SL02-2GESFP+	2779210000
	4 x 10GBaseSFP+			IE-SWM-SL04-4GESFP+	2779220000

Series / family	Ports	Function	Application	Power	Description	Part Number
Routers and 4G 	2 x RJ45 + 1 x RS232/422/485 + 2DI + 1DO	Wifi 802.11b/g/n	Wifi Security Router	12 / 24 / 48 VDC, PoE	IE-SR-2TX-WL	2682590000
		Wifi 802.11b/g/n, 4G LTE	Wifi 4G Security Router		IE-SR-2TX-WL-4G-EU	2682560000

Series / family	Ports	Supported Protocols	Application	Power	Description	Part Number
Universal Gateway Protocol Converter 	2 x RJ45 + 2 x RS232/RS485	Ethernet/IP (client), Modbus TCP (client/server), Modbus RTU (client/server), Modbus ASCII (client/server), S7comm (ISOTCP client),	Simultaneously converter between multiple protocols, enables communication between different fieldbuses and PLCs offered by Rockwell, Siemens, Schneider and more	12-24V DC	IE-UGW-2TX-2RS232/485	7940124932
	2 x RJ45 + 4 x RS232/RS485				IE-UGW-2TX-4RS232/485	7940124933

Series / family	Ports	Application	Power	Description	Part Number
Serial to Ethernet Converter 	2 x RJ45 + 1 x RS232/422/485	Serial to Ethernet Conversion. Modbus RTU to Modbus TCP conversion.	12 / 24 / 48 VDC	IE-CS-MBGW-2TX-1COM	2682600000

INDUSTRIAL ETHERNET CONNECTIVITY

Solutions for connection of Ethernet cabling.
Choose from a large number of interfacing options
for RJ45, Fibre Optic, USB and more.



Series / family				
DIN rail outlets				
	Type	RJ45-RJ45 Coupling	RJ45-RJ45 Coupling Angled	RJ45 Field Wireable
	Description	IE-TO-RJ45-C	IE-XM-RJ45/RJ45	IE-TO-RJ45-FJ-A
	Part Number	8946920000	8879050000	8946930000
	Type	RJ45 Field Wireable Angled	LC-LC Multimode	LC-LC Singlemode
	Description	IE-XM-RJ45/IDC	IE-TO-LCD-MM	IE-TO-LCD-SM
	Part Number	8808360000	8947010000	8947020000
	Type	ST-ST Fibre	SC-SC Multimode	SC-SC Singlemode
	Description	IE-XM-ST/ST	IE-TO-SCD-MM	IE-TO-SCD-SM
	Part Number	8808340000	8946970000	8946980000
Type	RJ45 Coupling	Single pair Ethernet (SPE)		
Description	IE-TO-RJ45-C-LP	IE-TO-SPO-C-LP		
Part Number	2812440000	2870790000		
RJ45 plugs				
	Type	Field wireable Plug	Field wireable Plug with Cable Gland	Field wireable Plug 90°
	Description	IE-PS-RJ45-FH-180-A-1.6	IE-PS-RJ45-FH-180-A-1.6-CG	IE-PS-RJ45-FH-90-A-1.6
Part Number	1992820000	2703390000	1992870000	
FrontCom Micro Service Interface				
	Type	RJ45-RJ45 Coupling	RJ45 Field wireable	USB Type A Coupling
	Description	IE-FCM-RJ45-C	IE-FCM-RJ45-FJ-A	IE-FCM-USB-A
	Part Number	1018790000	1018810000	1018840000
	Type	USB Type A to Type B	USB 3.0 Coupling	Single pair Ethernet (SPE)
Description	IE-FCM-USB-AB	IE-FCM-USB 3.0-A/A	IE-FCM-SPO-C	
Part Number	1222550000	1427960000	2870820000	
IP67 Connectivity-Bayonet Metal				
	Type	Field wireable Plug	RJ45-RJ45 Coupling bulkhead	Field wireable bulkhead
	Description	IE-PS-V01M-RJ45-FH-BP	IE-BS-V01M-RJ45-C	IE-BS-V01M-RJ45-FJ-A
Part Number	1963130000	1963470000	1963480000	
IP67 Connectivity-Bayonet Plastic				
	Type	Field wireable Plug	RJ45-RJ45 Coupling bulkhead	Field wireable bulkhead
	Description	IE-PS-V01P-RJ45-FH	IE-BS-V01P-RJ45-C	IE-BS-V01P-RJ45-FJ-A
Part Number	1012490000	1012370000	1012380000	

INDUSTRIAL ETHERNET CONNECTIVITY

Solutions for connection of Ethernet cabling.
Choose from a large number of interfacing options
for RJ45, Fibre Optic, USB and more.



Series / family				
D-Coded M12 Connectors				
	Type	Field wireable Plug Screw	Field wireable Plug PUSH-IN	M12 D-code female to RJ45 Straight
	Description	SAISM-4/8S-M12-4P D-COD	SAISP-M-4D-4/8-M12	IE-M12-ADAP 2
	Part Number	1892120000	2681680000	8901620000
	Type	Field wireable Plug 90° Screw	Field wireable Plug 90° PUSH-IN	M12 D-code male to RJ45 Straight
Description	SAISW-4/8S-M12-4P D-COD	SAISWP-M-4D-4/8-M12	IE-AD-M12DRJ45-MF-180	
Part Number	1160550000	2681690000	1514970000	
X-Coded M12 Connectors				
	Type	Field wireable Plug	M12 X-code to RJ45 Straight	-
	Description	IE-PS-M12X-P-FH	IE-AD-M12XRJ45-180	-
	Part Number	1324020000	1400620000	-

Series / family		Type	Grey	Blue	Black	Green	Red	Magenta	Yellow
RJ45 Patch Cabling		0.5 m	1165940005	1165900005	1251610005	1251590005	1166030005	1201270005	1251580005
		1 m	1165940010	1165900010	1251610010	1251590010	1166030010	1201270010	1251580010
		1.5 m	1165940015	1165900015	1251610015	1251590015	1166030015	1201270015	1251580015
		2 m	1165940020	1165900020	1251610020	1251590020	1166030020	1201270020	1251580020
		3 m	1165940030	1165900030	1251610030	1251590030	1166030030	1201270030	1251580030
		5 m	1165940050	1165900050	1251610050	1251590050	1166030050	1201270050	1251580050
		10 m	1165940100	1165900100	1251610100	1251590100	1166030100	1201270100	1251580100

Series / family		Plastic Lid - Cabinet Key Lock	Metal Lid - Cabinet Key Lock
IP65 Service Interface Kits			
	Type	1x 10A GPO + 1xRJ45 + 1xUSB + Touch Protection	1x 10A GPO + 1xRJ45 + 1xUSB + Touch Protection
	Description	IE-FC-SET-IPAUS01-CAB-P	IE-FC-SET-IPAUS01-CAB-M
	Part Number	7940127809	7940127810

REMOTE IO

Meet the most innovative I/O system on the market, u-remote. u-remote takes the most user-friendly I/O concept and combines this with high-performance hardware in a compact size.



- Built-in webserver for easy configuration
- Dual RJ45 ports (Ethernet Models)
- Separated dual 10A Input/output power bus
- Integration with most major PLC Vendors, Allen Bradley, Siemens, Schneider

Series / family	Description	Function	Power Bus	Max Modules	Part Number
Fieldbus Coupler	UR20-FBC-EIP	Ethernet/IP	10A input module bus & 10A output module bus, expandable with Power Feed modules	64 active I/O	1334920000
	UR20-FBC-EIP-V2 ●	Ethernet/IP, DLR & PRP redundancy support			1550550000
	UR20-FBC-MOD-TCP-V2	Modbus TCP			2476450000
	UR20-FBC-PN-IRT-V2	PROFINET IO (IRT, RT), MRP, S2 redundancy			2566380000
	UR20-FBC-PB-DP-V2	PROFIBUS DP-V1			2614380000
	UR20-FBC-EC	EtherCAT			1334910000

● DLR + PRP Redundancy supported





Series / family	Type	Channels	Function	Description	Part Number
I/O Slice	Digital Input	16	1-wire	UR20-16DI-P	1315200000
			1-wire, PLC ribbon interface	UR20-16DI-P-PLC-INT	1315210000
	Digital Output	8	2-wire	UR20-8DI-P-2W	1315180000
			1-wire	UR20-16DO-P	1315250000
	Digital In/Out	8	1-wire, PLC ribbon interface	UR20-16DO-P-PLC-INT	1315270000
			2-wire	UR20-8DO-P	1315240000
	Relay Output	4	Changeover relay	UR20-4RO-CO-255	1315550000
			Relay output, 250V 6A max	UR20-4RO-CO-255	1315550000
	Solid State Output	4	SSR output, 250VAC 1A max	UR20-4RO-SSR-255	1315540000
			4-wire 4-20mA / 0-10V input 16bit	UR20-4AI-UI-16	1315620000
	Analogue Input	4	4-wire 4-20mA / 0-10V input 16bit, diagnostic	UR20-4AI-UI-16-DIAG	1315690000
			4-wire 4-20mA input 16bit + HART	UR20-4AI-HART-16-DIAG	2617520000
	Analogue Output	4	4-wire 4-20mA / 0-10V output 16bit	UR20-4AO-UI-16	1315680000
			4-wire 4-20mA / 0-10V output 16bit, diagnostic	UR20-4AO-UI-16-DIAG	1315730000
Temperature Input	4	4-wire RTD input	UR20-4AI-RTD-DIAG	1315700000	
		2-wire Thermocouple input	UR20-4AI-TC-DIAG	1315710000	
Load Cell	2	4-wire Load cell input 24bit	UR20-2AI-SG-24-DIAG	1990070000	
		Serial	UR20-1COM-232-485-422-V2	2826800000	
Power Feed	Power Feed	0	Input bus 10A	UR20-PF-I	1334710000
		0	Output bus 10A	UR20-PF-O	1334740000

*More modules models in full catalogue

CONTROLLERS AND HMI

Modular controls for industrial automation and IoT applications. Industry trend drives towards convergence of IT and OT systems. The modular u-control M3000 and M4000 control systems lead the way to the future. The powerful controller works as an edge device for providing local information in the network and can be expanded by connecting function modules – ideal for automation and IIoT applications.



Series / family	Software applications	Hardware Specifications	Connections	Operating Temperature	Expandability	Description	Part Number
Edge & IIoT Controller	    CODESYS  , Node-RED, Docker, Easyconnect, PROCON-Web, u-link, App Hub, edgeML	Dual core A9, 624 MHz, 512 Mbyte RAM, 4GB embedded flash, 32GB via microSD, RTC, 128 KB NVRAM	2 x RJ45, 1 x Micro USB	-20°C ~ 55°C	Yes, with UR20 I/O slices	UC20-WL2000-AC	1334950000
		Dual core A53, 1200 MHz, 2 GB RAM, 16GB embedded flash, 32GB via microSD, RTC, 128 KB NVRAM	2 x 1Gbps RJ45, 2 x USB-A, 1 x USB-C	-40°C ~ 70°C		UC20-M3000	2839150000
		Quad core A53, 1200 MHz, 4 GB RAM, 16GB embedded flash, 32GB via microSD, RTC, 512 KB NVRAM	4 x 1Gbps RJ45, 2 x USB-A, 1 x USB-C	-40°C ~ 70°C		UC20-M4000	2839160000
		Dual core A9, 600 MHz, 1 GB ram, 4GB embedded flash, RTC	2 x RJ45, 1 x USB-A 1 x RS232/422/485, 1 x CAN, 2 x DI, 1 x DO	-20°C ~ 60°C	No	IOT-GW30	2682620000
			4G-LTE, 2 x RJ45, 1 x USB-A 1 x RS232/422/485, 1 x CAN, 2 x DI, 1 x DO			IOT-GW30-4G-NA	2682640000

● Requires license

Series / family	Resolution	Screen Size	Touch Technology	Technology	Operating Temperature	IP Rating	Description	Part Number
HMI Touch Panel (HTML5)	1024 x 600	7"	Multi-touch P-CAP	ARM® Cortex™-A53, quad-core 1.6 GHz, 4GB DDR4 RAM, 16 GB eMMC storage	-20°C ~ 60°C	IP66 (front)	UV66-ADV-7-CAP-W-V2	2932870000
	1280 x 800	10"					UV66-ADV-10-CAP-W-V2	2933040000
	1920 x 1080	15.6"					UV66-ADV-15-CAP-W-V2	2932860000
		21.5"					UV66-ADV-21-CAP-W-V2	2987520000

Series / family	Type	Code Size	Max I/O Channels	Basic Features*	Modbus/CANopen instances	EIP/PN/ECAT Instances	MultiCore (up to..)	Part Number
CODESYS Licences	U-OS-CODESYS-BASIC-S	500 kB	64	✓	-	-	-	2924000000
	U-OS-CODESYS-BASIC-M	1 MB	128	✓	2	-	-	2924020000
	U-OS-CODESYS-BASIC-L	3 MB	256	✓	2	-	-	2924030000
	U-OS-CODESYS-STANDARD-S	3 MB	512	✓	4	1	-	2924040000
	U-OS-CODESYS-STANDARD-M	5 MB	1024	✓	4	1	-	2924050000
	U-OS-CODESYS-STANDARD-L	6 MB	2048	✓	4	2	2 Cores	2924060000
	U-OS-CODESYS-PERFORMANCE-M	8 MB	4096	✓	4	2	4 Cores	2924070000
U-OS-CODESYS-PERFORMANCE-L	10 MB	8192	✓	4	4	4 Cores	2924080000	

ENERGY METERING

Energy data acquisition with an excellent price-performance ratio.
The practical solution for monitoring basic electrical data of machines and systems.



Series / family	Inputs	Voltage Range (L-N)	Input Type	Accuracy Class	Communication	Mounting	Description	Part Number
	1-phase	176-276V AC	1A/5A CT	Class 1	Modbus RTU RS485, Pulse	DIN mount	EM110-RTU-2P	7760051002
			Direct connect 45A				EM111-RTU-2P	7760051001
	3-phase	138-276V AC	1A/5A CT	Class 0.5			EM120-RTU-2P	7760051004
			Direct connect 100A				EM122-RTU-2P	7760051003
	50-345V AC	1A/5A CT	Class 0.5s	Modbus RTU RS485, Pulse, 4DI, 2DO		EM220-RTU-4DI2DO	7760051005	
				Modbus TCP, Modbus RTU RS485, Pulse, 4DI, 2DO		EM220-RTU-4DI2DO-GW	7760051006	

Series / family	Primary Current	Secondary Current	Class	Description	Part Number
	60A	5A	1	CMA-31-60-5A-1,25VA-1	2421380000
	75A			CMA-31-75-5A-2,5VA-1	1482040000
	100A			CMA-31-100-5A-2,5VA-1	1482030000
	150A			CMA-31-150-5A-5VA-1	2420960000
	200A			CMA-31-200-5A-5VA-1	2420950000
	250A			CMA-31-250-5A-5VA-1	2420940000
	400A			CMA-31-400-5A-5VA-1	2420920000
	500A			CMA-31-500-5A-5VA-1	2420910000
	600A			CMA-31-600-5A-5VA-1	2420900000
	750A			CMA-31-750-5A-5VA-1	2420890000

Series / family	Input	Output	Accuracy	Application	Description	Part Number
	100-5000A AC (using RCMA-B22 Rogowski Coil)	0-1A AC	<0.5% of measuring range	Rogowski coil transducer, for connection to 1A input energy meter	RCMC-5000-1A-P	2593400000

Series / family	Max Primary Current	Conductor Size	Cable Length	Application	Description	Part Number
	5000A AC	70 mm	4.5m	Rogowski coil, large diameter cables	RCMA-B22-D70-4.5	2593340000
		125 mm			RCMA-B22-D125-4.5	2593350000
		175 mm			RCMA-B22-D175-4.5	2593360000

TERMSERIES PLC RELAYS

Termseries, the all-rounder interposing relay for PLCs and controls. Choose from a wide range of electromechanical relays and solid-state relays in screw or PUSH IN connection.



Series / family		Coil Voltage	Load* Max	Contacts	Contact material	Application	Description	Screw	PUSH IN
Electromechanical Relay	TRS 1CO TRS 2CO TRS 1CO PB TRP 1CO TRS 1CO 16A	5VDC	6A	1CO	AgNi	General purpose	TRS 5VDC 1CO	1122740000	2614830000
		12VDC	6A	1CO			TRS 12VDC 1CO	1122750000	2618180000
			8A	2CO			TRS 12VDC 2CO	1123480000	2618550000
		24VDC	6A	1CO			AgNi + Gold	Very low current / voltage switching	TRS 24VDC 1CO
			8A	2CO	TRS 24VDC 2CO	1123490000			2618400000
			6A	1CO	AgNi	Actuator switching	TRS 24VDC 1CO AU	1123000000	2618110000
			8A	2CO			TRS 24VDC 2CO AU	1123730000	2618530000
			6A	1NO	AgSnO	Moderate inrush	TRS 24VDC ACT	1381900000	2618230000
			16A	1CO			TRS 24VDC 1CO 16A	1479680000	2618100000
		24V AC/DC	6A	1NO	AgSnO + W	Capacitive loads, LED drivers	TRS 24VDC 1NO AGSNO	1984540000	2618020000
	16A		1NO	TRS 24VDC 1NO HC			1479780000	2618090000	
	6A		1CO	AgSnO	General purpose + Test button	TRS 24VDC 1CO AGSNO PB	2855870000	2855800000	
	8A		1CO			TRS 24VDC 1CO	1122780000	2618220000	
	8A		2CO	AgNi	General purpose	TRS 24VDC 2CO	1123500000	2618320000	
	6A		1CO			TRS 24VDC 1CO AGSNO PB	2855890000	2855810000	
	6A		1CO	AgNi + Gold	Very low current / voltage switching	TRS 24VDC 1CO AU	1123010000	2618160000	
	8A		2CO			TRS 24VDC 2CO AU	1123740000	2618540000	
	48V AC/DC		6A	1CO	AgNi	General purpose	TRS 48VDC 1CO	1122790000	2618240000
	120V AC/DC		8A	2CO			TRS 48VDC 2CO	1123510000	2618520000
		6A	1CO	TRS 120VDC 1CO			1122810000	2618010000	
230V AC/DC	6A	1CO	TRS 230VDC 1CO	1122820000			2618050000		
24-230V AC/DC	8A	2CO	AgNi	AC switching with RC filter	TRS 230VDC 2CO	1123540000	2618440000		
	6A	1CO			TRS 230VAC RC 1CO	1122840000	2618200000		
	6A	1CO	AgNi + Gold	General purpose	TRS 24-230VDC 1CO	2662850000	2663010000		
	8A	2CO			TRS 24-230VDC 2CO	2662880000	2663040000		
6A	1CO	AgSnO	General purpose + Test button	TRS 24-230VDC 1CO AGSNO ED2 PB	2855930000	2855910000			
Solid State Relay		12VDC	100mA	1NO	Transistor	PLC I/O Interposing	TOS 12VDC 48VDC0.1A	1126930000	2618600000
		24VDC					TOS 24VDC 48VDC0.1A	1126940000	2618790000
		230V AC/DC	2A	MOSFET	High load switching	TOS 24VDC 24VDC2A	1127170000	2618720000	
			3.5A			TOS 24VDC 24VDC3.5A	1127630000	2618700000	
			5A			TOS 24VDC 24VDC5A	1990960000	2618840000	
		24-230V AC/DC	100mA	Transistor	AC interposing	TOS 230VDC 48VDC0.1A	1126990000	2618690000	
1A AC	1A AC	TRIAC	TOS 24-230VDC 48VDC0.1A	1127020000	2663070000				
TOS 24-230VDC 230VAC1A	1127500000	2663090000							
Forcibly Guided Relay		24V AC/DC	6A	2CO	AgNi	Forcibly guided to EN 61810-3 type B	TRS 24VDC 2CO FG	2706290000	2706430000
Timer Relay		24VDC	6A	1CO	AgSnO	Timer - On Delay, One Shot, Blinker, 0-100s	TRS T 24VDC 1CO M3	2639560000	2639730000
Compact Relay	TRPL 1CO	24V DC	6A	1NO	AgNi	PLC Interposing, built-in Fuse (5x20)	TRPL 24VDC 1NO F	-	2773930000
		5VDC					TRPL 5VDC 1CO	-	2774030000
		24VDC					TRPL 24VDC 1CO	-	2773890000
		24V AC/DC					TRPL 24VDC 1CO	-	2773970000
	TRPL 1NO FUSE	12-60V AC/DC	1CO	1CO	AgNi	Compact General Purpose	TRPL 12-60VDC 1CO	-	2773770000
		24-230V AC/DC					TRPL 24-230VDC 1CO	-	2773860000
		120V AC					TRPL 120VAC 1CO	-	2773800000
		230V AC					TRPL 230VAC 1CO	-	2773830000
Accessories	TIAL	-	-	-	-	8 x 6mm relays. 10-pole connector	TIA F10 8X1CO	-	1463520000
		-	-	-	-	16 x 6mm relays. 20-pole connector	TIAL F20 16X1CO	-	1463550000
		-	-	-	-	8 x 12mm relays. 10-pole connector	TIAL F10 8X2CO	-	1463540000
		-	-	-	-	Partition Plate	TXL PP	-	2774090000
		-	-	-	-	Feedthrough module	TXPL FT	-	2774080000
-	-	-	-	Supply module	TXPL S	-	2774100000		

Series / family		Colour	2-pole	10-pole	51-pole	Series / family	26-pole
1CO (6mm wide relay)		Orange	2556350000	2556360000	2556370000	2CO (12mm wide relay)	2556380000
		Red	2556390000	2556400000	2556410000		2556420000
		Blue	2556430000	2556440000	2556450000		2556460000
		Black	2556470000	2556480000	2556490000		2556500000

*Resistive load rating only. For inductive loads please see relay selection guide



GENERAL RELAYS

General purpose industrial relays.
Compact relays for use in general purpose switching applications with a wide selection of stocked models suited to your load.



Series / family	Coil Voltage	Load Max	Contacts	Contact material	Application	Description	Part Number
DRI Industrial relay - 1 C/O with Test button, LED, diode* (DC)	12V DC	10A	1CO	AgSnO	General Purpose Industrial Relay	DRI 12VDC LDT/1CO	7760056314
	24V DC					DRI 24VDC LDT/1CO	7760056315
	48V DC					DRI 48VDC LDT/1CO	7760056316
	110V DC					DRI 110VDC LDT/1CO	7760056317
	24V AC					DRI 24VAC LT/1CO	7760056318
	115V AC					DRI 115VAC LT/1CO	7760056319
	230V AC					DRI 230VAC LT/1CO	7760056320
DRI Industrial relay - 2 C/O with Test button, LED, diode* (DC)	12V DC	5A	2CO			DRI 12VDC LDT/2CO	7760056339
	24V DC					DRI 24VDC LDT/2CO	7760056340
	48V DC					DRI 48VDC LDT/2CO	7760056341
	110V DC					DRI 110VDC LDT/2CO	7760056342
	24V AC					DRI 24VAC LT/2CO	7760056343
	115V AC					DRI 115VAC LT/2CO	7760056344
	230V AC					DRI 230VAC LT/2CO	7760056345

Series / family	Type	Description	Part Number	Description	Cross Connect	Cross connect
Base DRI	PUSH-IN	SDI 1CO P	7760056364	SCM/SDI P CC	2 way	7760056366
	Screw	SDI 1CO	7760056350	SRC-I QV S	8 way	1132070000
	PUSH-IN	SDI 2CO P	7760056365	SCM/SDI P CC	2 way	7760056366
	Screw	SDI 2CO	7760056351	SRC-I QV S	8 way	1132070000

Series / family	Coil Voltage	Load Max	Contacts	Contact material	Application	Description	Part Number
DRM Industrial relay - 2 C/O with Test button, LED, diode* (DC)	12V DC	10A	2CO	AgNi	General Purpose Industrial Relay	DRM 12VDC 2CO LT	7760056068
	24V DC					DRM 24VDC 2CO LT	7760056069
	48V DC					DRM 48VDC 2CO LT	7760056070
	110V DC					DRM 110VDC 2CO LT	7760056071
	24V AC					DRM 24VAC 2CO LT	7760056073
	115V AC					DRM 115VAC 2CO LT	7760056075
	230V AC					DRM 230VAC 2CO LT	7760056076
DRM Industrial relay - 4 C/O with Test button, LED, diode* (DC)	12V DC	5A	4CO			DRM 12VDC 4CO LT	7760056096
	24V DC					DRM 24VDC 4CO LT	7760056097
	48V DC					DRM 48VDC 4CO LT	7760056098
	110V DC					DRM 110VDC 4CO LT	7760056099
	24V AC					DRM 24VAC 4CO LT	7760056101
	115V AC					DRM 115VAC 4CO LT	7760056103
	230V AC					DRM 230VAC 4CO LT	7760056104

Series / family	Type	Description	Part Number	Description	Cross Connect	Cross connect
Base DRM	PUSH-IN	SCM 2CO P	7760056362	SCM/SDI P CC	2 way	7760056366
	Screw	SCM 2CO ECO	7760056263	SCM-I QV S	8 way	1132080000
	PUSH-IN	SCM 4CO P	7760056363	SCM/SDI P CC	2 way	7760056366
	Screw	SCM 4CO ECO	7760056264	SCM-I QV S	8 way	1132080000







Series / family	Coil Voltage	Load Max	Contacts	Contact material	Application	Description	Part Number
Safeseries Forcibly Guided Relays	24V DC	6A	3NO1NC	AgSnO + Au	Forcibly Guided Safety relay	FSKIT 24VDC 3NO1NC FG LD	2759070000
			2NO2NC			FSKIT 24VDC 2NO2NC FG LD	2759080000
			4NO2NC			FSKIT 24VDC 4NO2NC FG LD	2759090000
			3NO3NC			FSKIT 24VDC 3NO3NC FG LD	2759100000
			5NO1NC			FSKIT 24VDC 5NO1NC FG LD	2860020000
MICROOPTO Special Loads	24V DC	10A	1NO	Power MOSFET	10A Solenoid driver	MOS 24VDC/5-33VDC 10A	8937940000
		2A			2A Solenoid driver	MOS 24VDC/8-30VDC 2A	8937970000
		50mA			High switching frequency	MOS 12-24VDC 100KHZ	8937990000
Timer Relays	24-230V AC/DC	5A	1CO	AgNi	Timer: on-delay, off-delay, single shot, clock generator, flip-flop. 0-10 h	ITS 24-240VUC 1CO M7C	2496190000
	12-230V AC/DC	8A			Timer: on-delay, off-delay, single shot, clock generator, flip-flop. 0-100 h	TFIS 12-240VUC 1CO M7C	2697250000

SIGNAL CONDITIONING

Interface between analogue signals and control.

The ACT20 series of analogue signal converters provide a wide range of conversion and isolation solutions for typical industry instrumentation or process requirements.



Series / family	Input Type	Output Type	Channels (in/out)	Size	Application	Power	Description	Part Number	
ACT20 Series  ACT20M  ACT20P-PRO  ACT20P-CMT  ACT20X	4-20mA	4-20mA	1/1	6mm	General isolation	24VDC	ACT20M-CI-CO-S	1175980000	
			1/2				ACT20M-CI-2CO-S	1175990000	
			1/1	12mm	HART transparent		ACT20P-CI-CO-S	7760054114	
			1/2		HART splitter		ACT20P-CI-2CO-S	7760054115	
			2/2	HART transparent	ACT20P-2CI-2CO-12-S	7760054117			
			1/1	6mm	Active input	Output loop	ACT20M-CI-CO-OLP-S	1176040000	
			2/2				ACT20M-2CI-2CO-OLP-S	1176050000	
			1/1	12mm	General isolation		ACT20P-CI-2CO-OLP-S	7760054119	
			1/2	12mm	Loop splitter		ACT20P-CI-2CO-OLP-S	7760054122	
			1/1	6mm	General isolation	Input loop	ACT20M-CI-CO-ILP-S	1176070000	
			2/2				12mm	ACT20M-2CI-2CO-ILP-S	1176080000
			1/1	12mm	ACT20P-CI-CO-ILP-S		7760054123		
			2/2	12mm	ACT20P-2CI-2CO-ILP-S		7760054124		
			0-10V 4-20mA	0-10V 4-20mA	1/1	6mm	Active input	24VDC	ACT20M-AI-AO-S
	1/2	Passive input			ACT20M-AI-AO-E-S		1176010000		
	Universal Input	4-20mA	1/1	12mm	Active input splitter	ACT20M-AI-2AO-S	1176020000		
			1/1		6mm	Active Input	ACT20P-AI-AO-DC-S		1477420000
	2 x 1CO Relay	2 x 1CO Relay	1/1	12mm	Universal programmable isolator	Output Loop 24VDC	ACT20M-UI-AO-S ●	1176030000	
			1/2	22mm			ACT20P-UI-AO-DO-LP-S ●	1453210000	
	0-300VDC 0-100mA	0...±20mA 0...±10V		12mm	Universal V/I converter push-button configurable	24-230V AC/ DC	ACT20P-PRO DCDC II-S	1481970000	
	RTD	0-10V 4-20mA			6mm	Temperature Transducer	24VDC	ACT20M-RTI-AO-S	1375510000
	Thermocouple							ACT20M-TCI-AO-S	1375480000
	RTD Thermocouple	4-20mA					Output loop	ACT20M-RTCI-CO-OLP-S	1435590000
	RTD Thermocouple Resistance Potentiometer	0...±20mA 0...±10V		1/1	12mm	Universal temperature converter push-button configurable	24-230V AC/ DC	ACT20P-PRO RTCI-AO-DO-S	2448100000
	0-10A AC/DC	0-10V 4-20mA 1CO Relay			17mm	Direct Connect	24VDC	ACT20P-CML-10-AO-RC-S	2044850000
	0-30A AC/DC							Hall Effect Current Transducer	ACT20P-CMT-10-AO-RC-S
0-60A AC/DC							ACT20P-CMT-30-AO-RC-S	1510540000	
							ACT20P-CMT-60-AO-RC-S	1510440000	
0-660VDC 0-440VAC	0-10V 4-20mA			22mm	Voltage measurement	24-230V AC/ DC	ACT20P-VM-AO-S ●	7760054306	
0-400VAC							1phase Phase Monitoring Relay	ACT20P-VMR-1PH-H-S	7760054164
200-480VAC	2 x 1CO Relay		1/2		3phase Phase Monitoring Relay	Line powered	ACT20P-VMR-3PH-ILP-H-S	7760054165	
Frequency: NPN/PNP, TTL, NAMUR, Contact, Tacho, 0-100kHz	0-10V 4-20mA		1/1	6mm	Frequency measurement	24VDC	ACT20M-FRQ-AO-X-S	2825130000	
Frequency: NPN/PNP, TTL, NAMUR, Contact, PWM, 0-200kHz							0...+ 20mA, 0...+10V Digital output	12mm	24-230V AC/DC
ACT20X Hazardous Area  ACT20X	Safe Digital in	Hazardous Digital out	1/1	22mm	Limit switches, NAMUR from hazardous to safe area	24VDC	ACT20X-HDI-SDO-S	8965360000	
			2/2				ACT20X-HDI-SDO-RNO-S	8965340000	
			1/1				ACT20X-2HDI-2SDO-S	8965390000	
			2/2				ACT20X-2HDI-2SDO-RNO-S	8965370000	
	Hazardous Analogue in	Safe Analogue Out		1/1		Analogue sensor from hazardous to safe area	24VDC	ACT20X-SDI-HDO-L-S	8965400000
								2/2	ACT20X-SDI-HDO-H-S
	Safe Analogue in	Hazardous Analogue Out		1/1		Driving analogue valve in hazardous area	24VDC	ACT20X-2SDI-2HDO-S	8965420000
								2/2	ACT20X-HAI-SAO-S ●
	Hazardous Temperature in	Safe Analogue Out		1/1		RTD, Thermocouple from hazardous to safe analogue	24VDC	ACT20X-2HAI-2SAO-S ●	8965440000
								2/2	ACT20X-SAI-HAO-S ●
	Universal in	Safe Analogue Out		1/1		Universal hazardous input to safe analogue output	24VDC	ACT20X-2SAI-2HAO-S ●	8965460000
								2/2	ACT20X-HTI-SAO-S ●
							ACT20X-2HTI-2SAO-S ●	8965480000	
							ACT20X-HUI-SAO-S ●	8965490000	
CBX200 							CBX200 USB	8978580000	

● Requires CBX200 PC programming cable



PROCESS DISPLAYS

Simple monitoring of analogue instruments with ACT20D.
 The universal range of indicators in the ACT20D series allows for measurement, display and alarming of typical process signals from analogue instruments.



Series / family	Input Type	Output	Power	Display	Application	Configuration	Mounting	Description	Part Number	
Process Displays		4-20mA	-	Loop Powered	LCD ±9999, with backlight	Push button programming	Panel mount 1/8 DIN, IP65 front	Analogue process loop indicator, easy viewing in bright or dark installations	ACT20D-LCD-CHLP	2920000000
		4-20mA, 0-10V, 0-10kΩ Potentiometer, RTD, Thermocouple	4-20mA, 4xCO relay	21-253 VAC, 19.2-300 VDC	Red LED, 4 digit (-1999 to 9999)			Universal process indicator	ACT20D-LED-UI-AC-DC	2920050000
								Universal process indicator with programmable relay alarms and analogue output	ACT20D-LED-UI-A0-4RC-AC-DC	2920060000
								Frequency indicator, for measuring motor rotation, relay alarm for under/over speed, frequency to analogue conversion	ACT20D-LED-FI-A0-2RC-AC-DC	2920070000

Series / family	Output	Description	Part Number
Accessories	Extra protection for extreme environments. Flexible PVC	Protective Cover	2964330000

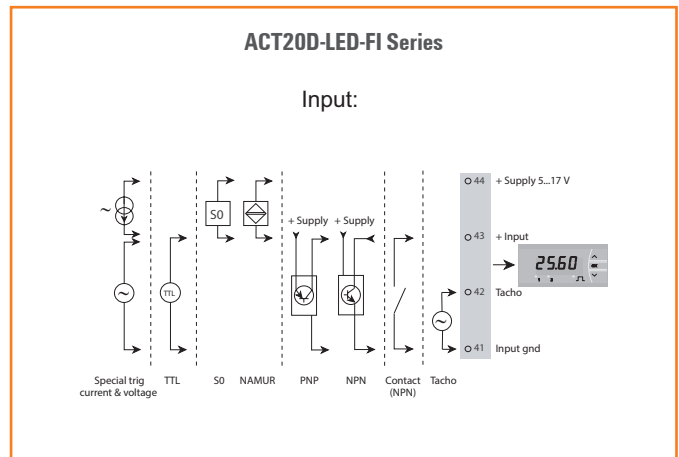
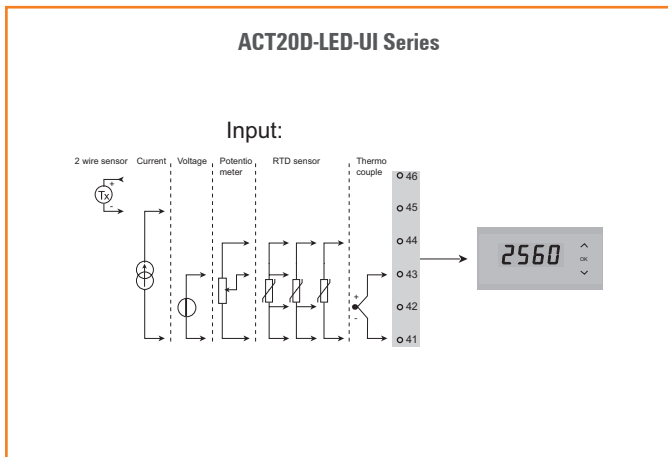

SURGE PROTECTION

Full protection for power, instrumentation and data.
Choose from a large number range of surge protection devices to suit your protection requirements.



Series / family	Network	Voltage	N-E Combined (MEN)	I _{max} (8/20us)	Application	Fault Contact	Description	Part Number	
Power Protection - VPU AC	3-phase	240 / 415VAC	●	100kA	Main Switchboard (High Exposure) Category C	Yes	VPU AC I 3 R 275/25 MB	2774960000	
			-				VPU AC I 3+1 R 275/25 MB	2638070000	
	1-phase	240 VAC	●	50kA	Sub distribution board (Medium Exposure) Category B		VPU AC I 1+1 R 275/100kA MB	2775000000	
			-				VPU AC I 1 R 275/100kA MB	2774940000	
	3-phase	240 / 415VAC	●	50kA	Sub distribution board (Medium Exposure) Category B		VPU AC II 3 R 300V/50	2591170000	
			-				VPU AC II 3+1 R 300V/50	2591090000	
	1-phase	240 VAC	●	50kA	Sub distribution board (Medium Exposure) Category B		VPU AC II 1+1 R 300V/50	2591070000	
			-				VPU AC II 1 R 300V/50	2591030000	
	DC	120 VAC	●	3kA	Final circuit or machine (Low Exposure) Category A		No	VPU AC II 1 300V/50	2591020000
			-	2kA			Yes	VPU III R 120V/6KV AC/DC	1351630000
-			2kA	Yes		VPU III R 48V/4KV AC/DC	1351600000		
-			2kA	Yes		VPU III R 24V/4KV AC/DC	1351580000		
DC	12 VDC	-	2kA	Final circuit or machine (Low Exposure) Category A	Yes	VPU III R 12V/4KV AC/DC	1351550000		
		-	2kA		Yes	VPU AC I F 1 R 275/25	2859340000		
		●	65kA		Main Switchboard (built-in fuse) Category B/C	Yes	VPU AC II F 3 R 300/40	2807410000	
		-					VPU AC II F 3+1 R 300/40	2807440000	
3-phase	240 / 415VAC	-	40kA	Sub distribution board (built-in fuse) Category B	Yes	VPU AC II F 1+1 R 300/40	2807430000		
		-				VPU AC II F 1 R 300/40	2807390000		
1-phase	240 VAC	●	20kA	Power supply surge protection Category B	Yes	VPU AC II+III 1+1 R 275/20 S	2907940000		
		-				VPU AC II+III 3 R 275/20 S	2907880000		

Series / family	Network	Voltage	Class	I _{max} (8/20us)	Application	Fault Contact	Description	Part Number
Photovoltaic - VPU PV	Photovoltaic	1000 VDC	I / II	40kA	Photovoltaic Systems (Separation distance not met)	Yes	VPU PV I+II 3 R 1000	2530620000
		1500 VDC		30kA			VPU PV I+II 3 R 1500V	2530590000
		1000 VDC	II	40kA	Photovoltaic Systems (Separation distance met)		VPU PV II 3 R 1000V	2530180000
		1500 VDC		30kA			VPU PV II 3 R 1500V	2530650000
Signal and Instrumentation - VSSC6	Analogue & Digital	30 VAC/DC	-	5kA	For current and voltage loops	No	VSSC6 CL 24VUC 0.5A	1064170000
		-	-	10kA	For digital signals		VSSC6 SL LD 24VUC 0.5A	1064350000
		15 VDC	-	10kA	RS485 2-wire		VSSC6 RS485	1064980000
		12 VDC	-	10kA	RS232 2-wire		VSSC6 RS232	1064990000
		24 VAC/DC	-	1kA	MOV protection for 24V devices		VSSC6 MOV 24VUC	1064540000
RJ45 Protection - VDATA	Data	48 VDC	-	10kA	Cat6A cabling, suitable for PoE devices to 802.3at/af/bt	No	VDATA CAT6	1348590000
	Data	48 VDC	-	10kA	Cat5E cabling, suitable for PoE devices to 802.3at/af/bt		VDATA CAT5E	2916360000

HEAVY DUTY CONNECTORS

Safe and reliable transmission of power, signals and data in industrial environments. Weidmüller's RockStar heavy duty connectors offer a robust pluggable connection from cabinet to field.

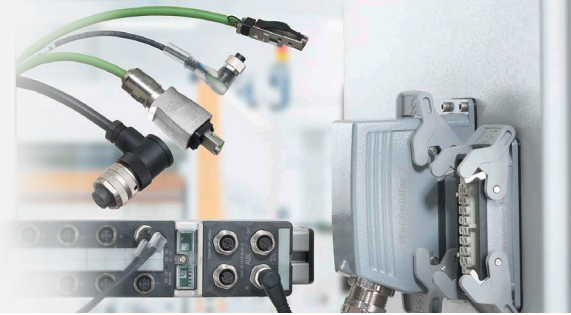

Series / family	Poles	Insert Socket Female		Insert Plug Male		Bulkhead Base	Surface Base	Hood Side Entry	Hood Top Entry	Cable Gland
		Screw	PUSH-IN	Screw	PUSH-IN					
Rockstar HDC	4	1498400000	-	1498300000	-	1497600000	-	-	1788820000	1772220000
		HDC HA 4 F		HDC HA 4 M		HDC 04A ALU	-	-	HDC 04A TOLU 1M20G	VG M20 - MS 68
	6	1200200000	1873520000	1200000000	1873530000	1202500000	1900360000	1788100000	1788120000	1772220000
		HDC HE 6 F		HDC HE 6 M		HDC 06B ADLU	HDC 06B SDLU 1M20G	HDC 06B TSLU 1M20G	HDC 06B TOLU 1M20G	VG M20 - MS 68
	10	1204100000	1873540000	1203900000	1873550000	1206500000	1903410000	1787580000	1787620000	1772230000
		HDC HE 10 F		HDC HE 10 M		HDC 10B ADLU	HDC 24D SDLU 1M25G	HDC 10B TSLU 1M25G	HDC 10B TOLU 1M25G	VG M25 - MS 68
	16	1207700000	1873560000	1207500000	1873570000	1210100000	1415810000	1788200000	1788230000	1772230000
		HDC HE 16 F		HDC HE 16 M		HDC 16B ADLU	HDC 16B SDLU 1M25G	HDC 16B TSLU 1M25G	HDC 16B TOLU 1M25G	VG M25 - MS 68
	24	1211300000	1873580000	1211100000	1873590000	1214300000	1904440000	1787790000	1787850000	1772240000
		HDC HE 24 F		HDC HE 24 M		HDC 24B ADLU	HDC 64D SDLU 1M32G	HDC 24B TSLU 1M32G	HDC 24B TOLU 1M32G	VG M32 - MS 68

*Other models available in full catalogue

1. Set on the number of poles required.
2. Pick your male and female insert as required in screw or PUSH-IN wiring connection.
3. Finish the kit with the recommended base hood and cable gland.

ModuPlug modular heavy duty connection system. More power, signal and data connections in less space and exactly what you need.

1. Pick your ModuPlug frame depending on how many insert slots you need. You will need an A-B and B-A frame set.
2. Pick your required inserts, both male and female for either end of the plug.
3. Finish the kit with the recommended base and hood.

Series / family	Slots Max	ModuPlug Frame		Bulkhead Base	Surface Base	Hood Side Entry	Hood Top Entry	Cable Gland
		A-B	B-A					
ModuPlug Housing	2	1428920000	1428940000	1202500000	1900360000	1788100000	1788120000	1772220000
	3	1428960000	1428980000	1206500000	1903410000	1787580000	1787620000	1772230000
	4	1429010000	1429030000	1210100000	1415810000	1788200000	1788230000	1772230000
	6	1429050000	1429070000	1214300000	1904440000	1787790000	1787850000	1772240000

Series / family	Slots Used	Insert		Poles	Current Rated	Connection Type	Wiring Diameter	Rated Voltage	
		Male	Female						
ModuPlug Inserts	1	2772820000	2772830000	2	40A	PUSH-IN	10mm ²	690V	
		2772780000	2772790000	3					
		2772800000	2772810000	4					
		2748320000	2748330000	2					40A
		2748300000	2748310000	2					70A
	2	2748280000	2748290000	2	100A	Screw	25mm ²	1000V	
		2748240000	2748250000	1	200A		35mm ²		
		2748400000	2748410000	5	16A		70mm ²		
	1	2748460000	2748470000	12	10A	PUSH-IN	1.5mm ²	230V	
		2636180000	2636190000	5	16A				
		2748420000	2748430000	6					
		2748440000	2748450000	8					
	1	2592030000	RJ45-RJ45 Coupler Female			-	RJ45 Cat6A	-	-
		2592210000	RJ45 Plug Male		-	-			
	0.5	1429040000	Dummy Module		-	-	-	-	

*Other models available in full catalogue

CIRCULAR CORDSETS

Secure connection of sensors and devices with Weidmüller's SAI range.
Explore our wide range of circular connectors suitable for signal, power and data.



Series / family		Size	Poles	Head Gender	Tail Gender	Length	Description	Straight	Angled		
Cordsets		M8 A-Coded	3	Male	Free	3m	SAIL-M8G-3-3.0U	1824590300	1857550300		
				Female		5m	SAIL-M8G-3-5.0U	1824590500	1857550500		
				Male		10m	SAIL-M8G-3-10U	1824591000	1857551000		
				Female		3m	SAIL-M8BG-3-3.0U	9457450300	9457380300		
				Male		5m	SAIL-M8BG-3-5.0U	9457450500	9457380500		
				Female		10m	SAIL-M8BG-3-10U	9457451000	9457381000		
				M12 A-Coded		4	Male	3m	SAIL-M8G-4-3.0U	1906270300	1857560300
							Female	5m	SAIL-M8G-4-5.0U	1906270500	1857560500
							Male	10m	SAIL-M8G-4-10U	1906271000	1857561000
							Female	3m	SAIL-M8BG-4-3.0U	9457850300	9456150300
							Male	5m	SAIL-M8BG-4-5.0U	9457850500	9456150500
							Female	10m	SAIL-M8BG-4-10U	9457851000	9456151000
		M12 A-Coded				3	Male	3m	SAIL-M12G-3-3.0U	9457810300	9456690300
							Female	5m	SAIL-M12G-3-5.0U	9457810500	9456690500
							Male	10m	SAIL-M12G-3-10U	9457811000	9456691000
							Female	3m	SAIL-M12BG-3-3.0U	9457820300	1061890300
							Male	5m	SAIL-M12BG-3-5.0U	9457820500	1061890500
							Female	10m	SAIL-M12BG-3-10U	9457821000	1061891000
				M12 A-Coded		4	Male	3m	SAIL-M12G-4-3.0U	9456100300	1906260300
							Female	5m	SAIL-M12G-4-5.0U	9456100500	1906260500
							Male	10m	SAIL-M12G-4-10U	9456101000	1906261000
							Female	3m	SAIL-M12BG-4-3.0U	9457730300	9457740300
							Male	5m	SAIL-M12BG-4-5.0U	9457730500	9457740500
							Female	10m	SAIL-M12BG-4-10U	9457731000	9457741000
	M12 A-Coded	5			Male	3m	SAIL-M12G-5-3.0U	9457610300	9457670300		
					Female	5m	SAIL-M12G-5-5.0U	9457610500	9457670500		
					Male	10m	SAIL-M12G-5-10U	9457611000	9457671000		
					Female	3m	SAIL-M12BG-5-3.0U	9457910300	9457690300		
					Male	5m	SAIL-M12BG-5-5.0U	9457910500	9457690500		
					Female	10m	SAIL-M12BG-5-10U	9457911000	9457691000		
			M12 A-Coded	5	Male	10m	SAIL-M12GM12G-5-10U	9457341000	-		
					Female	15m	SAIL-M12GM12G-5-15U	9457341500	-		

Series / family		Size	Connection Type	Poles	Outlet Type	Description	Male	Female
Field Wireable Connectors		M8	Screw	3	Straight	SAIB-M8-3P	1803860000	1803870000
				4		SAIB-M8-4P	1803850000	1803880000
		M12 A-Coded	Screw	5	Straight	SAIS-5/9	1807350000	1807250000
					Angled	SAIBW-5/9	1807370000	1807330000

TOOLS

With Weidmüller's professional tools, you can work faster, better, and more precisely than ever before. For over 50 years, we have been developing and manufacturing our comprehensive range of durable, high quality tools to meet the highest demands of cabinet assembly.



Series / family	KT 8	KT 12	KT 22	KT 40	KT 50	
Cutting Tools						
	Part Number	9002650000	9002660000	1157830000	2993490000	2993500000
	Application	Cable cutter, for copper or aluminium				
	Diameter	8mm	12mm	22mm	40mm	50mm

Series / family	STRIPAX	STRIPAX 16	STRIPAX ULTIMATE	
Stripping Tools				
	Part Number	9005000000	9005610000	1468880000
	Application	Flexible and solid conductors with PVC insulation		Flexible and solid conductors with halogen-free or tough insulation
	Cross Section	0.08-10mm ²	6-16mm ²	0.25-6mm ²

Series / family	PZ 2.5 S	PZ 6 ROTO	PZ 16	PZ 10 HEX	PZ 50	CTI 6	
Crimping Tools							
	Part Number	2903690000	9014350000	9012600000	1445070000	9006450000	9006120000
	Application	Trapezoidal crimp	Trapezoidal crimp	Indent crimp	Hexagonal crimp	Indent crimp	Insulated Spade and ring lugs
	Diameter	0.14-2.5mm ²	0.14-6mm ²	6-16mm ²	0.25-10mm ²	25-50mm ²	0.5-6mm ²

Series / family	STRIPAX PLUS 2.5	
Stripping and Crimping Tools		
	Part Number	9020000000
	Application	Cutter, stripper and crimper, uses strips of linked ferrules
	Cross Section	0.5-2.5mm ²

Series / family	CUT/STRIP/CRIMP SET	CRIMPSET PZ 10 HEX T	CRIMP-SET PZ 6 ROTO L T	CRIMP-SET STRIPAX PLUS T	
Sets					
	Part Number	8000120354	1542270000	9028700000	9028790000
	Contents	Stripax + PZ6 Roto + KT 8 + Screwdriver	PZ 10 HEX + Stripax + Ferrules (0.5 WT, 0.75 LTBL, 1.0 RD, 1.5 BK, 2.5 GY, 4.0 OR, 6.0 GN, 10.0 BRN)	Stripax + PZ6 Roto L + Ferrules (0.5 WT, 0.75 LTBL, 1.0 RD, 1.5 BK, 2.5 GY, 4.00 R, 6.0 GN)	Stripax Plus + Ferrules (0.5 WT, 0.75 LTBL, 1.0 RD, 1.5 BK, 2.5 GY)

*Ferrules Page 31



Cutting



Stripping











Crimping





TOOLS



With Weidmüller's professional tools, you can work faster, better, and more precisely than ever before. For over 50 years, we have been developing and manufacturing our comprehensive range of durable, high quality tools to meet the highest demands of cabinet assembly.



Series / family	VKSW	TSD 35	TSLD 5	
Workplace Tools				
	Part Number	1137530000	1318510000	9918700000
	Application	Duct Cutter	DIN rail cutter	DIN rail cutter and perforator
	Suitable Material	125mm wide duct	TS 35/7.5, TS 35/15	TS 35/7.5, TS 35/15, TS32, TS 15/5.5

Series / family	IE-CST	AM 16	AM 25	AM 35	AM-X	
Insulation Stripper						
	Part Number	9204350000	9204190000	9001540000	9001080000	2625720000
	Application	PVC cable insulation stripper				PVC round cable, unlimited size
	Cable Diameter	2.5-8mm	5-17mm	6-25mm	25-35mm	25mm-endless

Series / family	SDI SET S2.5-5.5/PH1/2	SDI SET SLIM S3.5-6.5/PH1/2	SD SET S2.5-5.5/PH1/2	SD EL SET 1.5-4.0/PH0/1	
Screwdrivers					
	Part Number	2749750000	2749580000	2749200000	2750160000
	Type	Insulated	Slim insulated	Non-insulated	Pico swivelhead
	Contains	PH1 x 80, PX2 x 100, Slotted (2.5 x 75, 3.0 x 100, 4.0 x 100, 5.5 x 125)			PH0 x 60, PH1 x 80, Slotted (1.5 x 40, 2.0 x 60, 2.5 x 75, 3.0 x 75, 4.0 x 100)

Series / family	CROSS-KEY UNIVERSAL	CROSS-KEY-DUO	CROSS-KEY-QUADRO
Cabinet Keys			
	Part Number	9918130000	1480190000

AUTOMATED MACHINES

More efficiency, less waste. Our automated cable assembly machines allow for reduced installation times which translate into smaller production costs, enhanced value and thus greater competitiveness. Get to know our automatic machines for professional and efficient cable preparation and processing.



Series / family	Type	Crimping range	Cable type	Cycle time	Details	Cycles per year	Description	Part Number	
Automated Machines - Crimpfix Eco		Automated wire stripper-crimper	0.5-2.5mm ²	PVC Cable only	<1.5s	Electrically driven, ferrule change by rotation of die. Weidmüller ferrules only	Up to 100,000	CRIMPFIX ECO	2833890000

Series / family	Type	Cutting Range	Cable type	Max number of cables	Details	Cycles per year	Description	Part Number	
Automated Machines - Cutfix Pro		Automated wire cutting	1 x 0.14-10mm ²	PVC, UL halogen free (soft/medium and hard insulation)	1	Electrically driven, software controlled wire change (FEEDER only)	Up to 200,000	CUTFIX PRO	2797190000
			11 x 0.5-2.5mm ² + 1 x 4-10mm ²		12			CUTFIX PRO FEEDER	2797200000

Series / family	Cross Section (mm ²)	L1	L2	D2	Colour	Pack Size	Description	Part Number
Ferrules for Crimpfix Eco	0.5	14	8	2.6	○ White	4000	H0,5/14DS W BD GSP	2528590000
	0.75			2.8	● Light Blue		H0,75/14TS HB BD GSP	2528630000
	1.0			3	● Red		H1,0/14DS R BD GSP	2528610000
	1.5			3.5	● Black		H1,5/14DS SW BD GSP	2528620000
	2.5			4.2	● Grey		H2,5/14T GR BD GSP	9005910000

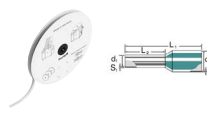

FERRULES

Outstanding quality: we ensure long-term connections.
Using wire-end ferrules ensures the long-term, consistent quality of your electrical connections. Our wide range of products comprise of single and twin boot wire end ferrules in a variety of sizes and conforming to industry standard colours.



Series / family	Cross Section (mm ²)	L1	L2	D2	Stripping Length	Colour	Pack Size	Description	Part Number
Ferrules with Plastic Collars - Packed loose 	0.5	14	8	2.6	10	○ White	500 (loose pack)	H0,5/14D W	9019010000
		16	10		12				H0,5/16D W
	0.75	14	8	2.8	10	● Light Blue		H0,75/14T HBL	9021040000
		18	12		14			H0,75/18T HBL	9021060000
	1.0	14	8	3	10	● Red		H1,0/14D R	9019080000
		18	12		15			H1,0/18D R	9019110000
	1.5	14	8	3.5	10	● Black		H1,5/14D SW	9019120000
		16	10		12			H1,5/16D SW	9019130000
		18	12		15			H1,5/18D SW	9019140000
	2.5	15	8	4.2	10	● Grey		H2,5/15T GR	9021070000
		19	12		14			H2,5/19T GR	9021080000
		25	18		20			H2,5/25T GR	9021090000
	4.0	18	10	4.8	12	● Orange		H4,0/18T OR	9021100000
		20	12		14			H4,0/20T OR	9021110000
		26	18		20			H4,0/26T OR	9021120000
	6.0	20	12	6.3	14	● Green		H6,0/20T GN	9021130000
		26	18		20			H6,0/26T GN	9021140000
	10.0	22	12	7.6	15	● Brown		H10,0/22T BR	9021150000
28		18	21			H10,0/28T BR	9021160000		
Ferrules with Wide Collar - Suitable for thicker insulation cable 	0.5	14	8	2.9	10	○ White	500 (loose pack)	H0,5/14S W	9004590000
	0.75	14	8	3.4		● Light Blue		H0,75/14TS HBL	9018550000
	1.0	14	8	3.5		● Red		H1,0/14S R	9018560000
	1.5	14	8	4		● Black		H1,5/14DS SW	9025240000

Series / family	Cross Section (mm ²)	L1	L2	A	Stripping Length	Colour	Pack Size	Description	Part Number
Twin Boot Ferrules with Plastic Collars - Packed loose 	0.5	14	8	5	11	○ White	500	H0,5/14D ZH W	9037380000
		18	12		15				H0,5/18D ZH W
	0.75	14	8	5.5	11	● Light Blue		H0,75/14T ZH HBL	9037610000
		16	10		13			H0,75/16T ZH HBL	9037620000
	1.0	15	8	5.8	11	● Red		H1,0/15D ZH R	9037440000
		19	12		16			H1,0/19D ZH R	9037450000
		25	18		22			H1,0/25D ZH R	9037460000
	1.5	16	8	6.5	11	● Black		H1,5/16D ZH SW	9037470000
		20	12		15			H1,5/20D ZH SW	9037480000
		26	18		21	100		H1,5/26D ZH SW	9037490000
	2.5	19	10	8	13	● Grey		H2,5/19T ZH GR	9037640000
		21	12		15	500		H2,5/21T ZH GR	9037650000
		27	18		21	100		H2,5/27T ZH GR	9037660000
	4.0	22	12	9	15	● Orange		H4,0/22T ZH OR	9037670000
28		18	21			H4,0/28T ZH OR	9037680000		

Series / family	Cross Section (mm ²)	L1	L2	D2	Stripping Length	Colour	Pack Size	Description	Part Number
Ferrules for Stripax Plus 2.5 - Strip of ferrules 	0.5	14	8	2.6	10	○ White	500 (strip of ferrules)	H0,5/14D W BD	9004280000
	0.75			2.8		● Light Blue		H0,75/14T HBL BD	9004310000
	1.0			3		● Red		H1,0/14D R BD	9004330000
	1.5			3.5		● Black		H1,5/14D SW BD	9004350000
	2.5			4.2		● Grey		H2,5/14T GR BD	9004370000

Series / family	Cross Section (mm ²)	L1	L2	D2	Stripping Length	Colour	Pack Size	Description	Part Number
Ferrules Box 	0.5	14	8	2.6	10	○ White	50	H-BOX 0.5-2.5QMM T	9023090000
	0.75			2.8		● Light Blue	100		
	1.0			3		● Red	100		
	1.5			3.5		● Black	100		
	2.5			4.2		● Grey	50		

MARKERS AND PRINTERS

Convenient, simple, multi-purpose.

The Multimark printing system provides a marking solution for the whole cabinet all from the same machine. From terminal marking, wire and cable marking or device label marking, a wide range of options exist for any application.



Series / family	Print Volume	Marking type	Big Pack (BP) support?	Description	Part Number
THM MultiMark Thermal Printer 	Small and medium print volumes	Terminal markers, wire markers, adhesive label markers, heatshrink markers	No, external roll holder required*	THM MULTIMARK	2599430000
	Medium to large print volumes		Yes	THM MULTIMARK PLUS	2599440000

Series / family	Width	Application	Length	Description	Part Number
MultiMark Accessories 	25mm	Terminal markers (DEK/WS)	360m	RIBBON MM-TB 25/360 BLACK	2005090000
	110mm	Wire markers (TM-H), Label markers		RIBBON MM 110/360 BLACK	2005070000
	60mm	Heatshrink markers	300m	RIBBON MM-HS 60/300 BLACK	2448880000
		External holder for big pack markers		THM MMP EXTENSION*	1302920000

Series / family	Height	Width	Marker Qty	Description	Supported Terminal Size*	A-series support	W-series support	Part Number
Dekafix Multimark 	5mm	3.5mm	1000	DEK 5/3.5 MM WS	1.5mm ²	●	●	2007100000
			15000	DEK 5/3.5 MM BP WS				2619760000
		5mm	800	DEK 5/5 MM WS	2.5mm ²	●	●	2007110000
			10000	DEK 5/5 MM BP WS				2619770000
		6mm	600	DEK 5/6 MM WS	4mm ²	●	●	2007120000
			9000	DEK 5/6 MM BP WS				2619780000
	8mm	500	DEK 5/8 MM WS	6mm ²	●	●	2007130000	
		6000	DEK 5/8 MM BP WS				2619790000	

Series / family	Height	Width	Marker Qty	Description	Supported Terminal Size*	A-series support	W-series support	Part Number
WS Multimark 	8mm	3.5mm	1000	WS 8/3.5 MM WS	1.5mm ²	●	●	2007140000
			11000	WS 8/3.5 MM BP WS				2619800000
		5mm	800	WS 8/5 MM WS	2.5mm ²	●	●	2007150000
			8000	WS 8/5 MM BP WS				2619810000
		6mm	600	WS 8/6 MM WS	4mm ²	●	●	2007160000
			6000	WS 8/6 MM BP WS				2619820000
	8mm	500	WS 8/8 MM WS	6mm ²	●	●	2007170000	
		5000	WS 8/8 MM BP WS				2619830000	
	10mm	5mm	800	WS 10/5 MM WS	2.5mm ²	●	●	2712130000
		6mm	600	WS 10/6 MM WS	4mm ²	●	●	2712140000
	12mm	5mm	800	WS 12/5 MM WS	2.5mm ²	-	●	2007190000
			5500	WS 12/5 MM BP WS				2619850000
		6mm	600	WS 12/6 MM WS	4mm ²	-	●	2007200000
			4500	WS 12/6 MM BP WS				2619860000
	8mm	500	WS 12/8 MM WS	6mm ²	-	●	2007210000	
		3500	WS 12/8 MM BP WS				2619870000	

Series / family	Numbering	Pack Size	Description	Horizontal	Vertical
Preprinted Dekafix 5/5 	1-10	5 lines per card, 10 cards per box	DEK 5 FX 1-10	0523060001	0460660001
	11-20		DEK 5 FX 11-20	0523060011	0460660011
	21-30		DEK 5 FX 21-30	0523060021	0460660021
	31-40		DEK 5 FX 31-40	0523060031	0460660031
	41-50		DEK 5 FX 41-50	0523060041	0460660041
	51-60		DEK 5 FX 51-60	0523060051	0460660051
	61-70		DEK 5 FX 61-70	0523060061	0460660061
	71-80		DEK 5 FX 71-80	0523060071	0460660071
	81-90		DEK 5 FX 81-90	0523060081	0460660081
	91-100		DEK 5 FX 91-100	0523060091	0460660091

MARKERS AND PRINTERS



Convenient, simple, multi-purpose.

The Multimark printing system provides a marking solution for the whole cabinet all from the same machine. From terminal marking, wire and cable marking or device label marking, a wide range of options exist for any application.



Series / family	Height	Width	Marker Qty	Description	Part Number
TM-I Wire Marker 	12mm	4mm	2000	TM-I 12 MM WS	2005440000
	15mm			TM-I 15 MM WS	2005450000
	18mm			TM-I 18 MM WS	2005470000
	20mm			TM-I 20 MM WS	2005490000
	23mm			TM-I 23 MM WS	2005510000
	30mm			TM-I 30 MM WS	2005530000

Series / family	Cable size	Description	Width					
			12mm	15mm	18mm	20mm	23mm	30mm
TM Transparent Sleeve 	0.25-1.5mm ²	TM 201	1798640000	1798620000	1798600000	1798580000	1507060000	1874850000
	0.5-2.5mm ²	TM 202	1798560000	1798540000	1798530000	1798520000	1507070000	1874760000
	2.5-10mm ²	TM 203	1798510000	1798490000	1798480000	1798470000	1507080000	1874770000
	6-16mm ²	TM 204	1806180000	1806240000	1806300000	1806360000	1507090000	1874780000
	16-35mm ²	TM 205	1806190000	1806250000	1806310000	1806370000	1507100000	1874790000
	35-120mm ²	TM 206	1806200000	1806260000	1806320000	1806380000	1507110000	1874800000

Series / family	Cable size	Width	Description	Marker Qty	White	Yellow
Heatshrink Cable Marker - Standard 	0.5-1.5mm ²	12mm	HS 1.0-3.2/12 MM	4000	2526070000	2526080000
		25mm	HS 1.0-3.2/25 MM	2000	2437510000	2437520000
	1.5-4mm ²		HS 1.6-4.8/25 MM	2000	2437550000	2437560000
	4-16mm ²	HS 3.2-9.5/25 MM	1000	2437670000	2437680000	
Heatshrink Cable Marker - Halogen Free 	0.5-1.5mm ²	25mm	HSS-HF 1/8 1.8-2.8/25Y	10,000	-	1961970000
			1.5-4mm ²	HSS-HF 3/16 2.8-4.2/25Y	8000	-
	4-10mm ²		HSS-HF 1/4 4.2-5.8/25Y	5000	-	1961990000
	10-16mm ²		HSS-HF 3/8 5.8-8.0/25Y	4000	-	1962000000
Heatshrink Halogen Free 	25-35mm ²	HSS-HF 1/2 8.0-11.0/25Y	3000	-	1962010000	
	35-70mm ²	HSS-HF 3/4 11.0-17.0/25Y	2500	-	1962020000	
	70-120mm ²	HSS-HF 1 17.0-23.0/25Y	1500	-	1962030000	

Series / family	Height	Width	Description	Marker Qty	White	Yellow	Silver
MT30X Adhesive Device Marker 	6	15	THM MT30X 15/6	10,000	1753231044	1753231687	1753230001
	9	15	THM MT30X 15/9		1058750000	1058740000	-
	9	17	THM MT30X 17/9		1968130000	1856650000	1356500000
	8	20	THM MT30X 20/8		1753241044	1753241687	-
	10	20	THM MT30X 20/10		2556240000	-	-
	12	25	THM MT30X 25/12		1751751044	1751751687	-
	20	30	THM MT30X 30/20	6000	1753261044	1753261687	1753260001
	19	38	THM MT30X 38/19	2000	1751801044	1751801687	-
	35	65	THM MT30X 65/35	1000	1751831044	1751831687	1751830001
	48	101	THM MT30X 101/48	500	1751821044	1751821687	1751820001

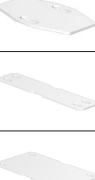
Series / family	Height	Width	Description	Marker Qty	White	Yellow
SFX Cable Marker 	9	24	SFX 9/24 MM	1000	2005320000	2005380000
	11	60	SFX 11/60 MM		2005340000	2005400000
	32	60	SFX 30/60 MM	300	2005360000	2005420000

CABLE ENTRY SYSTEMS

Cabtite - the modular cable entry system.

With the Cabtite cable entry system, assembled cables can be quickly and easily installed into an enclosure through the use of split sealing glands and frames which provide protection up to IP66.



Series / family		Installation	Protection Class	Frame Size	Description	Part Number
Cabtite Frame		Cabtite Standard Frame - Installation from inside enclosure	IP66	4 x small or 1 x large	CABTITE FR 4-1 BK SET	2583780000
				6 x small or 1 x large + 2 small	CABTITE FR 10/6 BK SET	2583760000
				8 x small or 2 x large or 1 x large + 4 x small	CABTITE FR 16/8 BK SET	2583740000
				10 x small or 1 x large + 6 small or 2 x large + 2 small	CABTITE FR 24/10 BK SET	2583720000
		Cabtite FrontTight - Installation from outside enclosure	IP66	4 x small or 1 x large	CABTITE FRFT 4-1 SET	2891470000
				6 x small or 1 x large + 2 small	CABTITE FRFT 10/6 SET	2891500000
				8 x small or 2 x large or 1 x large + 4 x small	CABTITE FRFT 16/8 SET	2891530000
				10 x small or 1 x large + 6 small or 2 x large + 2 small	CABTITE FRFT 24/10 SET	2891560000

Series / family	Installation	Protection Class	Frame Size	Cutout Size	Description	Part Number	
Cabtite Circular		Cabtite Circular Frame	IP66	1 x small	M20	CABTITE CGS M20 BK	2584200000
					M25	CABTITE CGS M25 BK	2584180000
					M32	CABTITE CGS M32 BK	2584160000
				1 x large or 4 x small	M40	CABTITE CGS M40 BK	2584150000
					M50	CABTITE CGS M50 BK	2584130000
					M63	CABTITE CGS M63 BK	2584120000

Series / family	Colour	Material	Number of Entries	Clamping Range	Description	Part Number
Cabtite Sealing Element - Small	Black	TPE, halogen free, Flammability rating: HB, UV Stabilised	1	1.5...2 mm	CABTITE SE 1.5-2 SML	2584780000
				2...3 mm	CABTITE SE 2-3 SML	2584760000
				3...4 mm	CABTITE SE 3-4 SML	2584730000
				4...5 mm	CABTITE SE 4-5 SML	2584680000
				5...6 mm	CABTITE SE 5-6 SML	2584710000
				6...7 mm	CABTITE SE 6-7 SML	2584690000
				7...8 mm	CABTITE SE 7-8 SML	2584670000
				8...9 mm	CABTITE SE 8-9 SML	2584330000
				9...10 mm	CABTITE SE 9-10 SML	2584080000
				10...11 mm	CABTITE SE 10-11 SML	2584060000
				11...12 mm	CABTITE SE 11-12 SML	2584040000
				12...13 mm	CABTITE SE 12-13 SML	2584020000
				13...14 mm	CABTITE SE 13-14 SML	2584000000
				14...15 mm	CABTITE SE 14-15 SML	2583980000
				15...16 mm	CABTITE SE 15-16 SML	2583960000
			2	4...5 mm	CABTITE SE 2/4-5 SML	2583620000
				5...6 mm	CABTITE SE 2/5-6 SML	2583610000
				7...8 mm	CABTITE SE 2/7 SML	2583550000
				8...9 mm	CABTITE SE 2/8 SML	2583540000
				3	5...6 mm	CABTITE SE 3/5-6 SML
4	2...3 mm	CABTITE SE 4/2-3 SML	2583590000			
	3...4 mm	CABTITE SE 4/3-4 SML	2583580000			
0	4...5 mm	CABTITE SE 4/4-5 SML	2583560000			
0	Blanking plug	CABTITE BSE SML	2584790000			

Series / family	Colour	Material	Number of Entries	Clamping Range	Description	Part Number
Cabtite Sealing Element - Large	Black	TPE, halogen free, Flammability rating: HB, UV Stabilised	1	14...15 mm	CABTITE SE 14-15 LRG	2583880000
				15...16 mm	CABTITE SE 15-16 LRG	2583860000
				16...17 mm	CABTITE SE 16-17 LRG	2583850000
				17...18 mm	CABTITE SE 17-18 LRG	2583840000
				18...19 mm	CABTITE SE 18-19 LRG	2583830000
				19...20 mm	CABTITE SE 19-20 LRG	2583810000
				20...21 mm	CABTITE SE 20-21 LRG	2583790000
				21...22 mm	CABTITE SE 21-22 LRG	2583770000
				22...23 mm	CABTITE SE 22-23 LRG	2583750000
				23...24 mm	CABTITE SE 23-24 LRG	2583730000
				24...25 mm	CABTITE SE 24-25 LRG	2583710000
				25...26 mm	CABTITE SE 25-26 LRG	2583700000
				26...27 mm	CABTITE SE 26-27 LRG	2583690000
				27...28 mm	CABTITE SE 27-28 LRG	2583680000
				28...29 mm	CABTITE SE 28-29 LRG	2583670000
29...30 mm	CABTITE SE 29-30 LRG	2583660000				

*VO Sealing elements available on request



OUR LOCATIONS

National footprint with strategic local stockholdings.

APS Industrial is headquartered in Melbourne and in addition has a national network of offices in Adelaide, Perth, Sydney, Brisbane and Tasmania supported by strategic local stockholdings and expert technical and application knowledge.

apsindustrial.com.au

CONNECT WITH US



MELBOURNE

5-7 Corporate Ave,
Rowville, Melbourne VIC 3178
Ph: (03) 8514 3500
Sales: 1300 309 303
Email: vic@apsindustrial.com.au

SYDNEY

391 Park Rd, Block P,
Regents Park, NSW, 2143
Ph: (02) 8898 6200
Sales: 1300 309 303
Email: nsw@apsindustrial.com.au

BRISBANE

49 Borthwick Avenue,
Murarrie, Brisbane, QLD, 4172
Ph: (07) 3063 3100
Sales: 1300 309 303
Email: qld@apsindustrial.com.au

ADELAIDE

159-163 Caulfield Ave,
Clarence Gardens, SA 5039
Ph: (08) 8111 5100
Sales: 1300 309 303
Email: sa@apsindustrial.com.au

PERTH

5 Glyde Court, Malaga,
Malaga, Perth WA 6090
Ph: (08) 6118 5300
Sales: 1300 309 303
Email: wa@apsindustrial.com.au

HOBART

441A Macquarie Street,
South Hobart, TAS, 7004
Sales: 1300 309 303
Email: tas@apsindustrial.com.au